

# Maintenance Instructions

**C100**

## Disclaimer

The illustrations in this documents may deviate from the delivered product. We reserve the right to make changes due to errors or based on technical advances.

## A Word on Copyright

This document is proprietary and was originally written in German. Its reproduction and distribution in whole or in individual parts without permission of the copyright owner is prohibited and will be prosecuted under criminal or civil law. All rights reserved, including for translation.

© Copyright by INDEX-Werke GmbH & Co. KG Hahn & Tessky

## Table of contents

<b>Preface</b> .....	<b>1</b>
General notes.....	1
Safety Instructions.....	1
<b>Service Interval - Care activities</b> .....	<b>5</b>
Maintenance Summary - Care activities.....	6
A010 - Check the work area door and window pane.....	7
A020 - Check hydraulic system (visual inspection).....	9
A027 - Replace the breathing filter at the filler neck of the hydraulic fluid tank.....	11
A040 - Check pneumatic system (visual inspection).....	13
A060 - Check filter on control cabinet cooling fan.....	15
A070 - Check filter on air conditioner cooling fan.....	17
A075 - Check fill levels of the fluid tanks.....	18
A080 - Clean and lubricate clamping device.....	21
A090 - Check electrical lines (visual inspection).....	23
A095 - Visual inspection of all fluid lines and electrical cables.....	24
A100 - Clean cooling lubricant outlet on clamping cylinder.....	25
A110 - Clean filter screens on chip conveyor.....	26
A120 - Check cooling lubricant (visual inspection).....	28
A128 - Check coolant.....	30
A147 - Check work area light (visual inspection).....	32
A180 - Clean the work area.....	33
A190 - Checking the wiper of counter spindle guide in the work area.....	34
A230 - Clean the chip conveyor.....	36
A280 - Clean labyrinth ring of spindles.....	39
<b>Service Interval - 1.000 Operating hours</b> .....	<b>41</b>
Maintenance Summary - 1.000 Operating hours.....	42
B010 - Customer area.....	43

<b>Service Interval - 2.000 Operating hours.....</b>	<b>45</b>
Maintenance Summary - 2.000 Operating hours.....	46
C010 - Check maintenance logs of servicing activities.....	47
C020 - Clean and check wipers and guide rails of the work area door.....	48
C035 - Check work area door (optionally with electr. drive) and window pane.....	51
C070 - Check outer wipers of linear guides.....	56
C080 - Check all electrical connections and drive belts of the drive motors.....	57
C090 - Replace wiper of counter spindle guide in the work area.....	59
C100 - Replace filter on cooling fan of main and counter spindles.....	60
C130 - Replace filter on air conditioner cooling fan.....	61
C140 - Check cooling unit for cooling lubricant.....	62
C155 - Check coolant.....	63
C190 - Clean labyrinth rings of spindles.....	65
C510 - Check backup data carrier.....	66
C520 - Check control cabinet.....	67
C540 - Check cable and hose clamps for tight seating.....	68
 <b>Service Interval - 4.000 Operating hours.....</b>	 <b>69</b>
Maintenance Summary - 4.000 Operating hours.....	70
D010 - Cleaning of the machine.....	71
D020 - Check the pressure accumulator.....	73
D050 - Check the lubrication system.....	74
D060 - Check the pneumatic system.....	76
D090 - Check main and counter spindles.....	79
D170 - Check the system for reconditioning the cooling lubricant.....	84
D180 - Check fire extinguishing system (visual inspection).....	85
D400 - Replacing hydraulic fluid.....	86
D460 - Check blanking plugs of the sliding tracks on the linear guides.....	90
D470 - Check wipers of upper telescopic covers.....	92
D480 - Replace wipers on the trolleys of the linear guides.....	93
D490 - Replacing wipers.....	94
D500 - Perform data backup.....	97
D520 - Check control cabinet and cable assemblies (visual inspection).....	98
D610 - Check batteries in NC/MMC operating panel on the INDEX C200-4D control and replace if necessary..	100
D640 - Check setting of electrical fuses.....	106

<b>Service Interval - 8.000 Operating hours</b> .....	<b>107</b>
Maintenance Summary - 8.000 Operating hours.....	108
E020 - Replace end position dampers.....	109
<b>Service Interval - 5 Years</b> .....	<b>111</b>
Maintenance Summary - 5 Years.....	112
I010 - Renewing the pneumatically pilot-controlled cooling lubricant valves.....	113
I020 - Replace the pressure accumulator.....	114
<b>Service Interval - 8 Years</b> .....	<b>117</b>
Maintenance Summary - 8 Years.....	118
J005 - Note on replacing the window pane or removing the design pane.....	119
J150 - Replace the window pane.....	122



## Preface

## General notes

The maintenance activities described in this document essentially pertain only to the machine. Maintenance activities of auxiliary units (e.g., bar loading magazines, extraction systems) are described in the documentation of the specific manufacturer.

The maintenance and servicing activities must absolutely be observed. Failure to conduct maintenance and servicing in accordance with these instructions (especially not at the respective intervals) rules out any claims for damages. This does not apply if it is proved that the non-compliance with the maintenance and servicing activities is unrelated to the defect. Normal wear and tear, especially of components such as bearings and seals, is not a defect. These components are therefore excluded from the warranty. It is recommended to keep a written log of all maintenance activities carried out.

**Maintenance intervals**

The maintenance intervals are given based on the operating hours counter / "Hydraulic system On" operating condition.

**Maintenance intervals displayed on the controller (iXpanel)**

Depending on the respective machine type and the different controller types, a corresponding message is issued on the controller when a maintenance interval is reached. The maintenance instructions stored on the respective controller provide information (maintenance log) explaining the service and maintenance activities to be performed.

**Cleaning of the machine****Do not clean the machine with compressed air**

- Raised dirt particles may cause breathing difficulty or injury (especially of the sensory organs). Furthermore, raised dirt particles or chips may reach spots where they cause technical problems.

**Do not use cotton waste for cleaning**

- When cleaning with cotton waste, fibers or thread can get loose causing safety problems.

**Solvents**

- Do not use highly volatile solvents such as petroleum spirit, trichloroethylene or similar cleaning agents. These cleaners may damage the seals, which can lead to safety problems.

**Pressure washers**

- Do not clean the machine with a pressure washer. Cleaning with a pressure washer results in strong corrosion. Furthermore, bearings may be degreased and seals may become leaking, which can lead to safety problems.



### **Cleaning of tool mountings**

A suitable cleaning tool must be used to clean the hole in the tool mounting.



### **Ordering spare parts**

Always specify the machine type and machine number when ordering spare parts. This and other information about the machine are located on the nameplate under the main switch of the control cabinet.



### **Operating material**

For all work in connection with operating materials, the information in the data sheets of the respective manufacturers and the information in the document **Notes on Operating Materials**.



### **Pressure accumulators $\leq 1$ L**

Pressure accumulators with a volume of  $\leq 1$  L are **not** subject to testing and labeling according to the current issue of the pressure equipment directive. The guidelines and regulations applicable in the country of use must be followed.

## Safety Instructions



### **Safety Instructions and Technical Details**

The user documentation and, in particular, the document "**Safety Instructions and Technical Details**" must be observed.





## **Carrying out maintenance work**

### **Authorized and trained personnel**

- Maintenance is to be performed only by authorized and trained personnel. This applies particularly to work on motors (spindle motors) or other electrical assemblies. The instructions in the respective manufacturer documentation must be followed for such work.

### **Allow the machine to cool down**

- Prior to working on the machine, it must be allowed to cool down, as hot parts may be located under the covers.

### **Maintenance work on machine being switched off**

- In general, maintenance is to be carried out with the machine switched off. The main switch must be locked out. Even when the main switch is switched off, parts of the machine (e.g., the control cabinet light) may still carry electricity. These parts are labeled. In a few cases, maintenance work needs to be performed with the machine turned on (e.g., replacement of backup batteries). These maintenance activities must be carried out with special care.

### **Required tools**

- For removing machine parts, suitable lifting gears and a variety of tools must be used. Removed machine parts must be placed in a safe position and secured against falling over.
- All maintenance work on the machine must be carried out with utmost care. Fasteners must be loosened carefully and parts must be secured against falling down. When elastic items (springs) are removed/replaced, appropriate devices must be used. Any (non-horizontal) axes that pose a risk of falling down must be moved to their end positions or secured against falling down. Pedal switches must be put aside to avoid inadvertent actuation.

### **Performing maintenance, repair or service work**

- The currently valid safety regulations, as well as the specific manufacturer's information for the intended use must be observed for these activities.

### **Use of climbing aids (ladders or steps)**

- In addition, appropriate climbing aids may be required to carry out these activities. When working on climbing aids at great heights, e.g. on the control cabinet, these must always be secured or fastened (depending on the machine, eyelets are also provided for this purpose).

**Procurement/use of spare parts**

We recommend the use of original spare parts and accessories. For damages caused by the use of parts from third-party providers, liability and warranty are excluded. The use of such products may change the structural characteristics of the machine and negatively affect the active or passive safety.

**Cellular and cordless phones**

When the control cabinet is open or the machine covers are open or removed, no cellular or cordless phones may be used within a 2 m radius.

**Handling hydraulic and hose lines**

Damaged hydraulic hose lines must be replaced immediately. Typical types of damage include chafing, kinks, cracks, deformations, or visible leaks.

Flexible, pressurized hydraulic hose lines of **INDEX** equipment are generally designed as thermoplastics or metallic hydraulic hose lines.

The machine operator/owner is responsible for compliance with the laws and regulations of the country of use with regard to the use of hydraulic hoses.

We recommend inspection and documentation of the hydraulic hose lines installed inside the machine and not directly visible every 12 months. For hydraulic hose lines visible in the work area or mounted outside the machine and connecting components to the machine, we recommend inspection and documentation every 6 months.

For the flexible, pressurized hydraulic hose lines used by **INDEX**, empirical values are available for very different periods of use, some of which exceed 10 years.

**Maintenance work on fluid systems (hydraulic, lubrication, and pneumatic systems)**

When carrying out maintenance work on fluid systems (hydraulic, lubrication, and pneumatic systems), make sure **before** starting the work that the respective system **has been depressurized** (accumulator drain valve / manual slide valve).

**Dry run or functional test**

After all maintenance work and work on electrical assemblies, a dry run or functional test must be performed.

**Service Interval - Care activities**

## Maintenance Summary - Care activities



It is recommended to document the maintenance activities carried out by using the appropriate maintenance log. The maintenance log has the document number LP1602.10101 - 15.08.2022.



The maintenance interval is highly dependent on the production and environmental conditions of the machine. The determination of the appropriate interval must be made by the operator.

**The maintenance interval should be between once per shift and once a week!**

- A010** - Check the work area door and window pane
- A020** - Check hydraulic system (visual inspection)
- A027** - Replace the breathing filter at the filler neck of the hydraulic fluid tank.
- A040** - Check pneumatic system (visual inspection)
- A060** - Check filter on control cabinet cooling fan
- A070** - Check filter on air conditioner cooling fan
- A075** - Check fill levels of the fluid tanks
- A080** - Clean and lubricate clamping device
- A090** - Check electrical lines (visual inspection)
- A095** - Visual inspection of all fluid lines and electrical cables
- A100** - Clean cooling lubricant outlet on clamping cylinder
- A110** - Clean filter screens on chip conveyor
- A120** - Check cooling lubricant (visual inspection)
- A128** - Check coolant
- A147** - Check work area light (visual inspection)
- A180** - Clean the work area
- A190** - Checking the wiper of counter spindle guide in the work area
- A230** - Clean the chip conveyor
- A280** - Clean labyrinth ring of spindles

## A010 - Check the work area door and window pane

### Orientation

Inspection and maintenance of the work area door includes several steps:

- Inspection of the window pane for damage.
- Checking the safety label on the window pane (replacement interval 8 years).
- Checking/adjusting or replacing, if necessary, the wipers.
- Check the work area door for smooth opening/closing.
- Automatic work area door (optional). Hydraulic valves and motor, control panel, rack and spur gear. (for hydraulic door drive)
- Automatic work area door (optional – electric door drive – follow the manufacturer's documentation).

The window pane consists of three panes. The inner pane made of tempered glass, the central pane made of polycarbonate, and the outer pane also made of polycarbonate. The inner pane is relatively resistant. It can be cleaned with any commercially available cleaning agents. Only the center pane is essential for the impact resistance of the window pane.

The polycarbonate panes are subject to **natural** aging and therefore must be subjected to regular visual inspection. Through contact with cooling lubricant, the aging process is accelerated even further



If the window pane is damaged, it must be replaced. This is necessary regardless of the extent of damage. Even with minimal damage, the impact resistance of the pane can no longer be guaranteed.

Heavily soiled or damaged wipers may cause damage to the inner pane. Moreover, it may be possible that the work area door can be moved only with considerable effort due to heavy soiling or chip deposits in the wipers.

Check the guide rails of the work area door. The guide bars must be checked and cleaned regularly so that the work area door can be moved without much effort.

### Procedure

1. Check window pane for damage.

2.



Clean the outer pane with a soft cloth or sponge and glass cleaner or soap and water. Do not use abrasive or alkaline cleaners (e.g., benzene, acetone or carbon tetrachloride) and no sharp tools or sharp objects (such as razor blades or screwdrivers).

Clean outer pane.

3. Clean inner pane.

4. Check wipers. Remove and clean the wipers. If the wipers are severely deformed or damaged, they must be replaced. To clean the door panels evenly, be sure to reinstall the wipers after their removal aligned in parallel and ensure that they snugly contact the work area door.

5. Check the work area door for ease of movement. To do so, open and close the work area door. If the work area door can be moved only with effort, determine the cause. Possible causes include – depending on the work area door – defective or improperly adjusted wipers. Chips on the guide bar or between the door and wiper, or in the guide rollers of work area door.

**A020** - Check hydraulic system (visual inspection)

## Orientation

To ensure trouble-free operation, periodic checks of the oil level are necessary. The fill level must be between the upper and lower marks on the oil sight glass.



Only use hydraulic fluid grade 15/13/10 in accordance with ISO 4406.

Viscosity other than 32 according to DIN ISO 3448 is not admissible.



For all work in connection with operating materials, the information in the data sheets of the respective manufacturers and the information in the document **Notes on Operating Materials** must be observed.



Example: Hydraulic system ABC



Screws on the hydraulic system, the connected components, and the supply lines must be tightened to the manufacturer's specified torques.

## Procedure

1.  The hydraulic fluid level should always be near the top mark when the machine is switched off. During production, the oil level may drop after several consumers have been connected.

Check oil level at the oil sight glass.

2. Visual inspection of the hydraulic fluid. The hydraulic fluid may not exhibit any foaming or cloudiness at the oil sight glass. In case of problems of this kind, immediately determine the cause and correct the error. If in doubt, take a sample for analysis and contact the manufacturer of the hydraulic fluid.
3. Check pressure setting on pressure gauge and adjust if necessary. The operating pressure is different depending on the machine type. See the fluid charts for the correct pressure setting.
4. Check supply and fluid lines (damage and leakage). Supply and fluid lines must be checked for damage. Pre-damage such as kinks or abrasions should be logged and replacement should be initiated.



**A027** - Replace the breathing filter at the filler neck of the hydraulic fluid tank.

## Orientation



The breathing filter on the oil filler neck of the oil tank must be Regular regularly replaced depending on the ambient conditions.



Due to different requirements and/or specifications of the respective manufacturers, be sure to review the respective manufacturer's documentation!



Filters are hazardous waste and must be disposed of in a controlled manner.

## Requirement

It is essential to keep the filter described here in stock. **It is not permitted to owner the machine without this filling and breathing filter.**



Use only the original filters according to the spare or wear parts list.



Only filters with retained particle sizes described in the fluid plans must be used.

## Procedure

1.



Example: Filling and breathing filters of hydraulic and lubrication systems (by ARGO-HYTOS GmbH)

Replace breathing filter.

## A040 - Check pneumatic system (visual inspection)

### Orientation

To ensure trouble-free operation, periodic checks of the pneumatic system are necessary.

- Check oil level at oiler (optional).
- Check pressure setting on pressure gauge.
- Check supply and fluid lines.
- Check silencers.
- Drain condensate (not applicable to auto-drain).

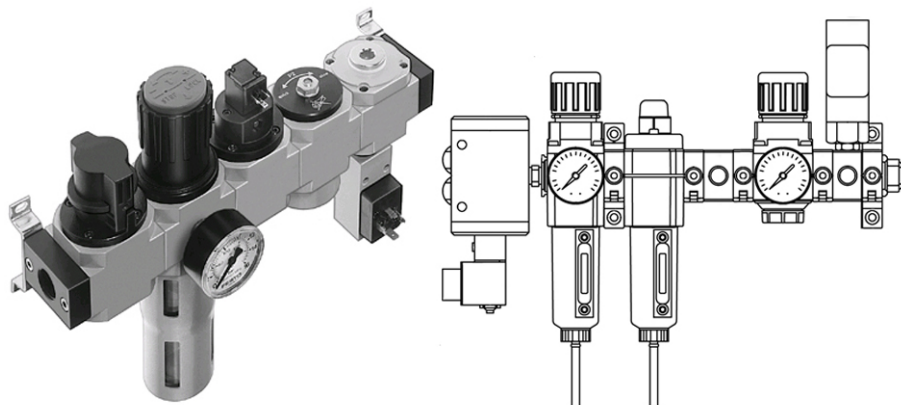

Example: Pneumatic maintenance unit by FESTO/ Norgren



Due to different requirements and/or specifications of the respective manufacturers, be sure to review the respective manufacturer's documentation!

### Procedure

1. Check oil level at oiler (optional).
2. Check pressure setting on pressure gauge and adjust if necessary. An operating pressure of 6 bar has been set at the factory.
3. Check supply and fluid lines (damage and leakage). Supply and fluid lines must be checked for damage. Pre-damage such as kinks or abrasions should be logged and replacement should be initiated.

4.



Example: Various silencer versions from FESTO/ Norgren

Check silencers.

5. Drain condensate (not applicable to auto-drain).

**A060** - Check filter on control cabinet cooling fan

## Orientation

The filters must be replaced regularly depending on the ambient conditions.



Whether air flow exists can quickly and easily be made visible by attaching a thread at the opening of the air outlet.



Use only the original filters according to the spare or wear parts list! Otherwise the machine is at risk of sustaining serious damage due to overheating.

## Requirement

A sufficient number of filters must be available.

## Procedure

1. Remove machine covers and/or filter housing cover.
- 2.



**Example: Filter on the control cabinet**

Check filter.

3.



**Example: Filter and filter cover**

Reinstall all covers.

**A070** - Check filter on air conditioner cooling fan

## Orientation

The filters must be replaced regularly depending on the ambient conditions.



Whether air flow exists can quickly and easily be made visible by attaching a thread at the opening of the air outlet.



Use only the original filters according to the spare or wear parts list! Otherwise the machine is at risk of sustaining serious damage due to overheating.

## Requirement

A sufficient number of filters must be available.

## Procedure

1. Remove cover frame.
2. Check the filters, replace if necessary.
3. Reinstall all covers.

## A075 - Check fill levels of the fluid tanks

### Orientation

To ensure the operational safety of the machine, the fill levels of all fluid tanks must be regularly checked, and topped off if necessary.

Operating fluids such as hydraulic fluids, cooling lubricants, lubricating greases/oils are also subject to degradation or aging like the components involved in this process, and must therefore be serviced, refilled or changed at regular intervals. Do not use cotton waste and highly volatile solvents such as petroleum spirit, trichloroethylene or similar cleaning agents. The machine must not be cleaned with compressed air. To ensure trouble-free operation, periodic checks of the oil level are necessary.

The hydraulic fluid and lubricating oil levels should always be near the top mark when the machine is switched off. During production, the oil level may drop after several consumers have been connected.

The interval for this maintenance activity is strongly dependent on the operating profile of the machine. If the machine is used in three-shift operation, this maintenance activity must be carried out much more frequently.

### Requirement



For all work in connection with operating materials, the information in the data sheets of the respective manufacturers and the information in the document **Notes on Operating Materials** must be observed.



Due to different requirements and/or specifications of the respective manufacturers, be sure to review the respective manufacturer's documentation!

### Procedure

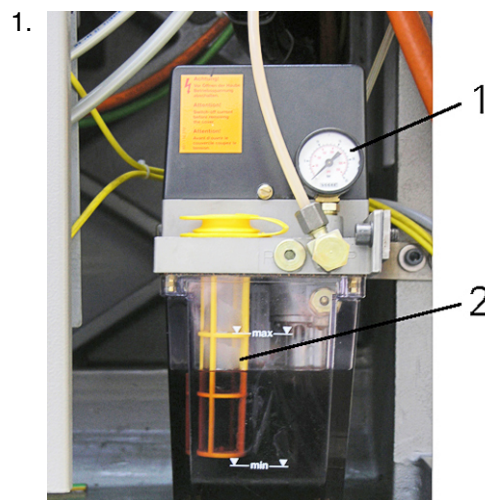

**Example: Lubricating oil tank**

- 1 Pressure gauge (lubrication pressure)
- 2 Filter insert and min./max. indicators



Check fill level at lubricating oil tank.

2.

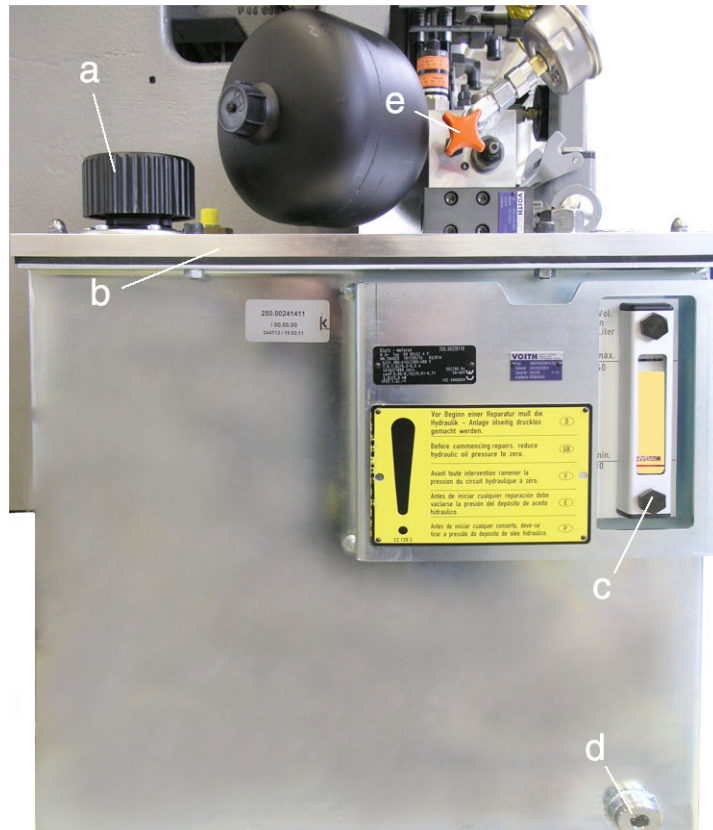

**Example: Hydraulic unit C100 C200 C200tandem**

- a** Filler neck
- b** Base plate of hydraulic system
- c** Fill-level check
- d** Drain plug
- e** Accumulator drain valve

Check fill level at hydraulic fluid tank.

3. Check fill level at cooling lubricant tank.

4.



**Fill level indicator at a cooling lubricant recycling system (Knoll)**

**X** Fill level indicator

Check the fill level at the cooling lubricant reconditioning system (option).

5. Check fill level of the coolant tank (option).

## A080 - Clean and lubricate clamping device

### Orientation

To ensure reliability and accuracy of the machine, clamping devices must be subjected to periodic maintenance.

The interval of this maintenance is strongly influenced by the type of material and daily production time. Especially for short chipping materials (e.g., brass or cast iron), these maintenance activities must be performed much more frequently.



Due to different requirements and/or specifications of the respective manufacturers, be sure to review the respective manufacturer's documentation!



Depending on the materials to be machined (e.g.: brass, cast iron) and the number of shifts per day, more frequent cleaning of the chuck is necessary.

For this, the clamping device must be removed and completely cleaned. Here, also the labyrinth ring (spindle cover) and the space behind the ring must be cleaned.

### Requirement



Example: Three-jaw chuck from different manufacturers.



**Do not use cotton waste for cleaning.**

When cleaning with cotton waste, fibers or thread can get loose causing safety problems.

### Procedure

1.



Caution

**Sharp contours on the clamping device**

**Cuts**

Use personal protective equipment (e.g., protective gloves)

Clean clamping devices

**Alternatively, the following procedure can be used!**

If necessary, unmount clamping devices for cleaning (follow manufacturer's instructions).

2. Lubricate clamping devices according to manufacturer's instructions.
3. Clean labyrinth ring and space behind the labyrinth ring.

## A090 - Check electrical lines (visual inspection)

### Orientation



Leave the immediate area around the machine and the additional units free; do not use it as storage or warehouse space. This significantly reduces the risk of damage to electrical lines.

Electrical lines routed outside the machine (e.g., lines for cooling lubricant systems, chip conveyor, and pedal switch) must be regularly checked for damage (e.g., pinching or cuts).

### Procedure

1.



#### **Damaged electrical lines.**

#### **Electric shock.**

Switch off machine and accessory units and arrange for immediate replacement of damaged lines by an electrically trained technician.

Check electrical lines to chip conveyor.

2. Check electrical lines to cooling lubricant system.
3. Check electrical lines to workpiece feeder.
4. Check electrical lines to workpiece removal unit.
5. Electrical leads for the pedal switches.
6. Check electrical lines of the working area light.
7. Check electrical line to sub-panel / handheld control unit (option).
8. Check electrical lines to other optional attachments.

## A095 - Visual inspection of all fluid lines and electrical cables

### Orientation

Depending on the duration of use, usage profile of the machine and different ambient conditions, it is absolutely necessary to subject all fluid lines and electrical cables to regular visual inspections. This allows that any faults or problems can be detected and eliminated early on.



Damaged fluid lines may cause leakage of fluids under high pressure. Be sure to use personal protective equipment during visual inspection.

### Requirement

Should defective points be found on fluid lines or electrical cables during the visual inspection, the machine must be switched off and the damaged lines or cables must be promptly replaced.



Replaced fluid lines must be tightened to the torque specified by the manufacturer.

### Procedure

1. Visual inspection of all supply and fluid lines.
2. Visual inspection of all electrical cables.

**A100** - Clean cooling lubricant outlet on clamping cylinder

## Orientation

During machining, the cooling flow flushes small chips through the spindle in the direction of the clamping cylinder. Therefore, the cooling lubricant outlet on the clamping cylinder must be cleaned at regular intervals.

## Procedure

1. Disassemble the machine enclosure in the area of the spindles.

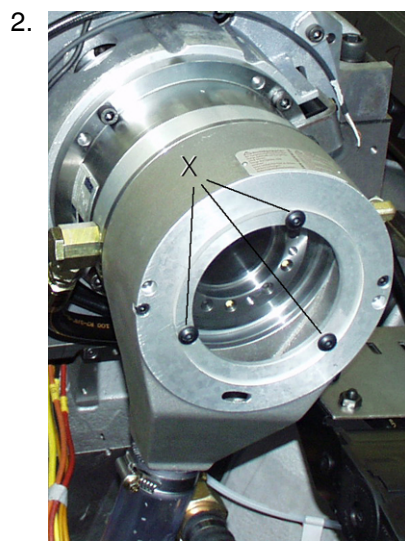

Example: Cooling lubricant outlet, G160

Remove any screws (X) and the acrylic glass cover on the cooling lubricant tank.

3. Clean cooling lubricant collection bin.
4. For assembly, follow the steps in reverse order. Ensure proper cleanliness during the installation.

## A110 - Clean filter screens on chip conveyor

### Orientation

The chip conveyor is used for removal of swarf from the work area and is also a reservoir for the cooling lubricant.

The cooling lubricant is filtered in the chip conveyor. For this purpose, various filters and filter plates are built into the chip conveyor. These filters must be cleaned regularly. In particular, make sure that the area around the cooling lubricant pump(s) is always free of chips or dirt.



For all work in connection with operating materials, the information in the data sheets of the respective manufacturers and the information in the document **Notes on Operating Materials** must be observed.



The chip conveyor must not be operated without the filters and filter plates provided by the manufacturer. Follow the manufacturer's documentation!

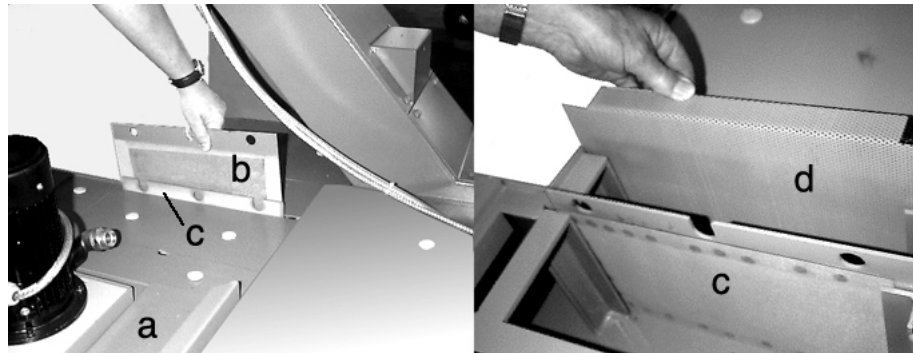

Example: Insert screens ABC

### Procedure

- Cooling lubricant splashing out of the chip conveyor.  
Skin irritation and damage to the eyes.**

Wear personal protective equipment (e.g., safety gloves and safety goggles).

Remove cover panels in the area of the cooling lubricant pump.

- Remove and clean filter and plug-in plates.
- Remove and clean magnetic filter plates (option).
- Remove and clean pre-filters (option) on the cooling lubricant pump.

- If the supply of cooling lubricant is insufficient, the strainer basket on the cooling lubricant pump must be cleaned.



Remove cooling lubricant pump. Remove and clean strainer basket on the cooling lubricant pump.

**Alternatively, the following procedure can be used!**

Extract cooling lubricant, remove screen directly from the cooling lubricant pump and clean it.

## A120 - Check cooling lubricant (visual inspection)

### Orientation



Follow the user documentation **Notes on Operating Materials** and the documentation of the cooling lubricant manufacturer.



For all work in connection with operating materials, the information in the data sheets of the respective manufacturers and the information in the document **Notes on Operating Materials** must be observed.

The cooling lubricant is subject to wear depending on the material and the generated temperature. Regular inspection is therefore essential.

In case of strong formation of odor, fungus or mold, the cooling lubricant emulsion must be changed at once. The principle of open lubrication may cause a slight commixture between cooling lubricant and hydraulic fluid. If the surface of the cooling lubricant tank is covered with a layer of oil, the cooling lubricant must be replaced. Furthermore, determine the cause of the oil ingress.



Synthetic cooling lubricants or cooling lubricant based on esters are not admissible.

If the type of cooling lubricant or the manufacturer is changed, make sure that the cooling lubricant meets the required specifications.

See the manufacturer's documentation for the fill quantities.



Regularly checking the cooling lubricant is necessary in particular if cooling lubricant emulsions containing mineral oil are used, so that the required properties are ensured.

### Requirement

A refractometer is required to determine the concentration.

### Procedure

1.



Caution

**Biological and chemical changes in the cooling lubricant.  
Skin irritation or respiratory and circulatory problems.**

Wear personal protective equipment (e.g., safety gloves and safety goggles).

Remove machine enclosure in the area of the cooling lubricant tank.

2. Visual and olfactory inspection of the cooling lubricant.

3. Check cooling lubricant emulsion. See document **Notes on Operating Materials**.

4. Check supply and fluid lines. Supply and fluid lines must be checked for damage. Pre-damage such as kinks or abrasions should be logged and replacement should be initiated.

## A128 - Check coolant

### Orientation

For add-on equipment that cannot be cooled conventionally with cooling lubricants or hydraulic fluid due to high temperature development, separate cooling is provided in an independent cooling circuit. The coolant used here must be checked continuously for its condition like other coolants.



Due to different requirements and/or specifications of the respective manufacturers, be sure to review the respective manufacturer's documentation!

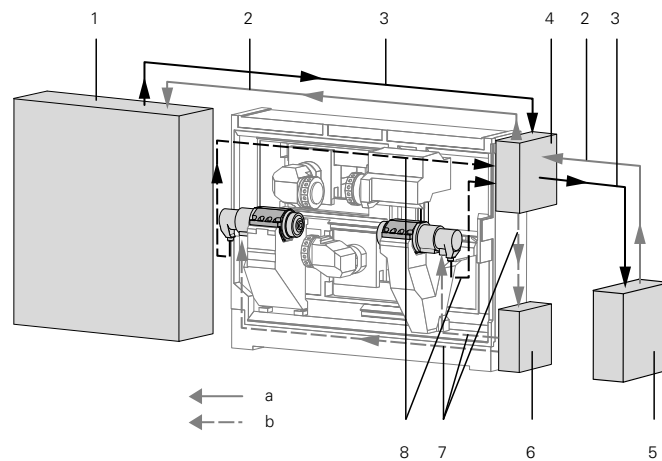

Schematic diagram of cooling system C100/C200

- 1 Control cabinet
- 2 Cold water
- 3 Warm water
- 4 Heat exchanger
- 5 External cooling unit, or customer-side cooling
- 6 Hydraulic fluid tank
- 7 Cold oil
- 8 Warm oil
- a Water circuit
- b Oil circuit



For all work in connection with operating materials, the information in the data sheets of the respective manufacturers and the information in the document **Notes on Operating Materials** must be observed.

### Requirement



Replenish only coolant of the same manufacturer having the same specification. Mixing different coolants may lead to corrosion of the cooling system and degradation of the coolant. The glycol content must be min. 25%.



When switching the coolant to another product or changing the manufacturer, the cooling system must be completely flushed and cleaned with this coolant. When preparing the coolant from concentrate and water, be sure to use demineralized water only. Only then the machine may be put back into operation.

### External Machine Cooling Water Supply

A	B	C	D	E	F
C100	20°C±2°K	25	3	8	8
C200	20°C±2°K	25	3	13	8

#### Technical data of cooling water supply C100/C200 C200tandem

- A** Machine
- B** Water temperature [°C]
- C** Cooling water, Q<sub>min</sub> / Q<sub>max</sub> [l/min]
- D** Differential pressure P<sub>inlet</sub> and P<sub>return</sub> [bar]
- E** Required cooling capacity [kW]
- F** Pressure in the cooling system [bar]

The information given in the Technical Data of the cooling water apply at an ambient temperature of max. 40 °C.



The values specified in the table must absolutely be observed! Deviating from these values will not ensure sufficient cooling of the machine.

The maximum operating pressure must not exceed 8 bar!



Due to different requirements and/or specifications of the respective manufacturers, be sure to review the respective manufacturer's documentation!



Be sure to replenish with a ready-mix. Mixing different glycol alkalis may trigger chemical reactions causing agglutination or clumping of the coolant.

## Procedure

1. Check coolant. Test criteria for this visual inspection are the clarity and transparency of the coolant.

## A147 - Check work area light (visual inspection)

### Orientation

To ensure even illumination of the working areas in the machine, work area lights are installed in the work area.

They enable safe working and should therefore be checked regularly. **Damaged lighting fixtures must be replaced immediately.**

### Procedure

1. Check all lamps (visual inspection).
- 2.



Example: Work area light G200, G300

Check lamp protective glass for damage. If cooling lubricant has already penetrated into the lamp protective glass of the work area light, the lamp must be repaired.

## A180 - Clean the work area

### Orientation

To ensure consistent quality, high availability and value retention, the machine must be regularly cleaned, depending on the operating conditions.

Of course, this is influenced by various factors. The use of emulsion as a cooling lubricant requires a more frequent and intensive cleaning.

Compared to machining producing long chips, machining producing short chips requires a considerably higher maintenance effort. Short chips, such as in the machining of brass or cast iron, form chip accumulations or become deposited in small cracks and corners. These positions must be cleaned regularly to avoid damage to the respective components.

Areas such as telescopic covers, rubber seals, sealing lips or wipers are particularly affected points. Frequent cleaning of these areas is particularly important.

### Requirement



Only the agents described in the documentation may be used for the cleaning and after-treatment of the machine.

Always use the proper tool to remove chips.

The following tools are required for cleaning:

- chip hooks,
- chip brushes,
- spray bottles of cleaners or cooling lubricant,
- a sufficient quantity of rags,
- oil to apply to the telescopic plates and all other bare parts by spraying or by brushes.

### Procedure

1.



**Chips and projecting tools in the work area.**

**Cuts.**

Use of personal protective equipment such as safety goggles and gloves, and appropriate tools.

Remove chips from the work area.

2. Chip accumulation particularly in the area of the tool carriers and the work area door.
3. Flush work area with cooling lubricant.
4. Wipe clean with rags.
5. Apply an oil film to bare metal plates and telescopic covers.
6. Examine any visible damage, and repair or replace, if necessary.

## A190 - Checking the wiper of counter spindle guide in the work area

### Orientation

Due to their open-access location, the counter spindle wipers may be contaminated or impaired by chips particularly hard.

Therefore, special attention should be given to the condition of the wipers during servicing and maintenance activities.

### Requirement

As part of servicing and maintenance, only periodic visual inspection of the wipers is necessary. However, if this visual inspection reveals damage to the wiper, it must be replaced immediately.

### Procedure

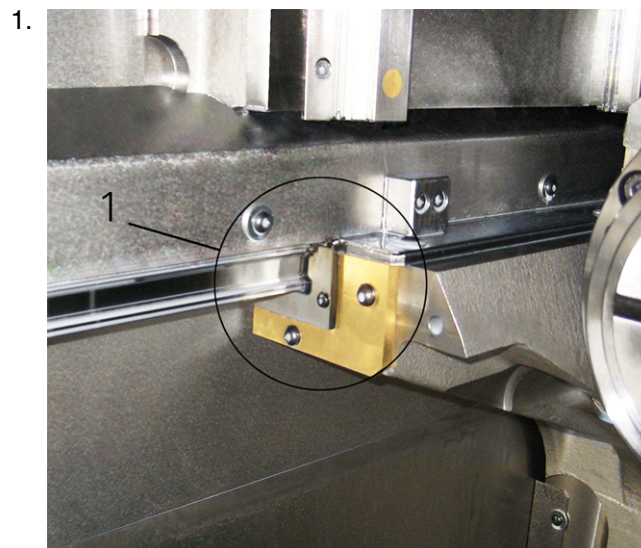

Example: Wiper (1) counter spindle C100/C200 C200tandem

Move counter spindle to working position.

2.



**Uncontrolled movements of tool carriers or accessories.**

**Cuts and crush injuries to hands and arms.**

Trigger an EMERGENCY STOP on the machine or switch off the machine completely.

Check wipers.

3. Replace any defective wiper. Unscrew wiper and push to the left of the guide bar. **Be sure to clean the space behind the wiper before inserting the new wiper.**
4. Oil the cleaned guide bar. This allows the wiper to be pushed easily over the guide bar. Slide new wiper carefully onto the guide bar.



5. Slide wiper again to the right up to the contact surface and fasten with the 2x M4 screws. **When securing the new wiper, make sure that the wiper evenly contacts the contour of the gib.**

## A230 - Clean the chip conveyor

### Orientation



Be sure to follow the respective manufacturer's documentation.

To ensure a smooth production process, the chip conveyor should be cleaned and serviced regularly. With regular cleaning, any defects can be detected and corrected early. Thus, prolonged downtime due to repair work can be reduced to a minimum. The chip conveyor is used for removal of swarf from the work area and is also a reservoir for the cooling lubricant. The cooling lubricant is filtered in the chip conveyor. For this purpose, various filters and filter plates are built into the chip conveyor. These filters must be cleaned regularly. In particular, make sure that the area around the cooling lubricant pump(s) is always free of chips or dirt.



For all work in connection with operating materials, the information in the data sheets of the respective manufacturers and the information in the document **Notes on Operating Materials** must be observed.

### Requirement



Be sure to interrupt the motion of the conveyor belt by opening the work area door or switching off the chip conveyor before commencing cleaning work around the discharge chute!



The conveyor belt can only move when the chip conveyor is switched on and the work area door is closed.

### Procedure

1. Clean the chip conveyor. Sweep accumulated chips from the tool carriers and chip deflectors onto the chip conveyor belt. Provide a collection bin at the chip discharge chute, close the work area door and switch on the chip conveyor. Continue to open the work area door frequently and clean the slats of the conveyor belt with a broom. If a hand shower (option) is available, it can be used to rinse the interior and the conveyor belt.
2. Clean the discharge chute. Pay particular attention to chip build-up and remove them around the discharge chute. Chip build-up can accumulate in the area of the drive roller so that it can become compacted, causing damage to the conveyor belt including the drive shaft.
3. Check the wipers at the discharge chute and the inlet port.
4. Visual inspection of brush-off device (option).

5.



Only one insert screen may be present in the chip conveyor during operation.

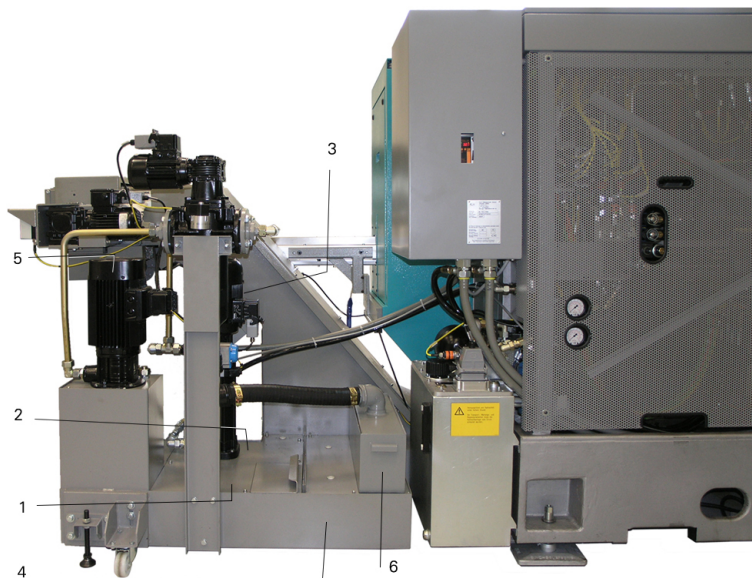

**Example: Chip conveyor C100 / C200 C200tandem**

- 1 Cover plate
- 2 Pump box
- 3 Booster pump
- 4 Chip conveyor with cooling lubricant tank
- 5 End supply pump
- 6 Sludge tank

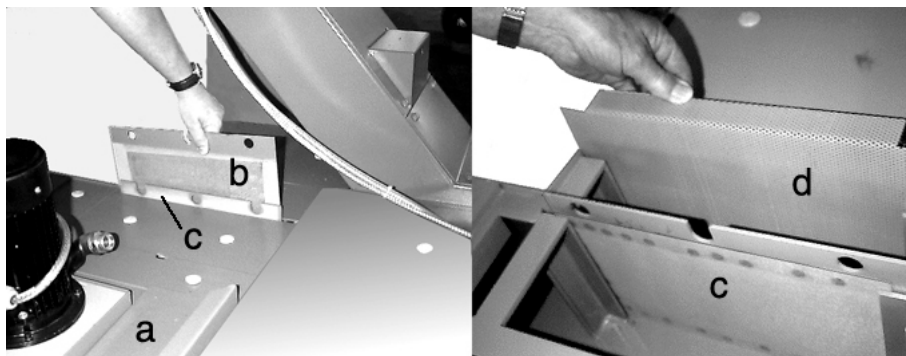

**Example: Screens**

- a Screen box
- b Insert screen (dirty)
- c Insert screen (cleaned)
- d Coarse screen

Clean screens and magnetic filter plates (option). To avoid clogging of the cooling lubricant channels, the insert screen, coarse screen and the magnetic filter plate (option) should be cleaned weekly or as appropriate depending on the degree of contamination of the chip conveyor. Insert a second, non-built-in insert screen at the motor side. This prevents sludge deposits and chips from entering the suction area of the pump. Then remove and clean the dirty screen, and have it ready for the next maintenance interval.

6. Remove and clean pre-filters (option) on the cooling lubricant pump.

7.



If the supply of cooling lubricant is insufficient, the strainer basket on the cooling lubricant pump must be cleaned.

Remove cooling lubricant pump. Remove and clean strainer basket on the cooling lubricant pump.

**Alternatively, the following procedure can be used!**

Extract cooling lubricant, remove screen directly from the cooling lubricant pump and clean it.

## A280 - Clean labyrinth ring of spindles

### Orientation



When machining short-chipping materials such as brass, cast iron, or in case of residues from the grinding, the work area must be cleaned more frequently due to the special nature of the contamination. Depending on the duration of use, usage profile of the machine and different ambient conditions, it is necessary in particular to remove and clean the labyrinth rings.



**Do not clean the machine with compressed air.**

Raised dirt particles may cause breathing difficulties or injuries (especially of the sensory organs).

Furthermore, raised dirt particles or chips may reach spots where they cause technical problems.



**Do not use cotton waste for cleaning.**

When cleaning with cotton waste, fibers or thread can get loose causing safety problems.

### Procedure

1. Loosen and remove the screws on the labyrinth ring (X) of the spindle. The number of screws that are necessary to fasten the labyrinth ring may differ depending on the type of machine.

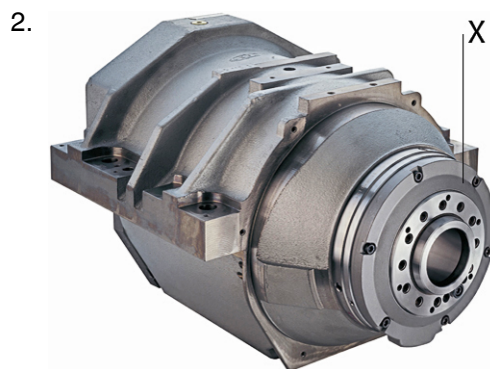

Example: (X) Labyrinth ring on the main spindle G200

Remove the labyrinth ring.

3. Clean the labyrinth ring. Clean the free space behind the labyrinth ring by hand with a cloth.
4. Reinstall the labyrinth ring and tighten the screws to the proper torque.



**Service Interval - 1.000 Operating hours**

## Maintenance Summary - 1.000 Operating hours



It is recommended to document the maintenance activities carried out by using the appropriate maintenance log. The maintenance log has the document number LP1602.10101 - 15.08.2022.

**B010** - Customer area



## B010 - Customer area

### Orientation

This area of the maintenance **B** for **1000h** is generally empty when the machine is delivered. This area is freely editable and is used by the customer to create their own maintenance activities/intervals or work.

For example:

- Interval for cleaning the work area and chip conveyor due to heavy contamination/chip accumulation from short-chipping materials.
- Interval for a filter change.
- Interval for testing the cooling lubricant.

Maintenance contents from the user documentation of additionally purchased peripheral devices that were **not** obtained from **INDEX** can also be transferred to this area.



The procedure for creating your own individual maintenance intervals/contents is described in the **iXpanel** document. This document is both the contents of the user documentation (in paper form) and can be found on the supplied data carriers in Chapter 1 "Instructions".

### Procedure

1. Acknowledgment of maintenance activities **B 1000h**.



**Service Interval - 2.000 Operating hours**

## Maintenance Summary - 2.000 Operating hours



It is recommended to document the maintenance activities carried out by using the appropriate maintenance log. The maintenance log has the document number LP1602.10101 - 15.08.2022.

- C010** - Check maintenance logs of servicing activities
- C020** - Clean and check wipers and guide rails of the work area door
- C035** - Check work area door (optionally with electr. drive) and window pane
- C070** - Check outer wipers of linear guides
- C080** - Check all electrical connections and drive belts of the drive motors
- C090** - Replace wiper of counter spindle guide in the work area
- C100** - Replace filter on cooling fan of main and counter spindles
- C130** - Replace filter on air conditioner cooling fan
- C140** - Check cooling unit for cooling lubricant
- C155** - Check coolant
- C190** - Clean labyrinth rings of spindles
- C510** - Check backup data carrier
- C520** - Check control cabinet
- C540** - Check cable and hose clamps for tight seating

## **C010** - Check maintenance logs of servicing activities

### Orientation

The maintenance logs on the performed maintenance activities allow you to review the maintenance activities carried out between two maintenance intervals. The logs may contain important indications as to work that may be necessary beyond the maintenance activities. Similarly, the logs can be used for determining the cause of malfunctions due to incorrect or inadequate maintenance activities carried out.

### Procedure

1. Check maintenance or inspection logs.

## C020 - Clean and check wipers and guide rails of the work area door

### Orientation



Regular inspection of the wipers prevents damage to the wipers themselves and to the work area door.

If the work area door can be opened and/or closed only with increased effort, it can be expected that the wipers are already destroyed by accumulation of chips and swarf compaction.

### Requirement



Example: Chip hook and chip brush

Use appropriate tools to remove coarse chips, chip nests and other debris.

### Procedure



Example: 1 Removing chip nest using appropriate tools (e.g., chip hooks)

Remove large chips on the inside of the work area door from top to bottom. Use a chip hook for this purpose.



Example: 2 Sweep small chips and other debris from top to bottom using chip brooms or brushes.

Remove small chips and chip accumulations on the inside of the work area door from top to bottom. Use a chip brush for this purpose.



Example: 3 upper wipers, G300

Clean wipers.

**Alternatively, the following procedure can be used!**

In case of heavy soiling or adhesion of chips to the wipers, the wipers and associated cover panels should at any rate be completely removed and cleaned. **In this case, also clean the area behind the wipers.**

- 4.
- 

Make sure that the wipers evenly contact the work area door before tightening the screws.

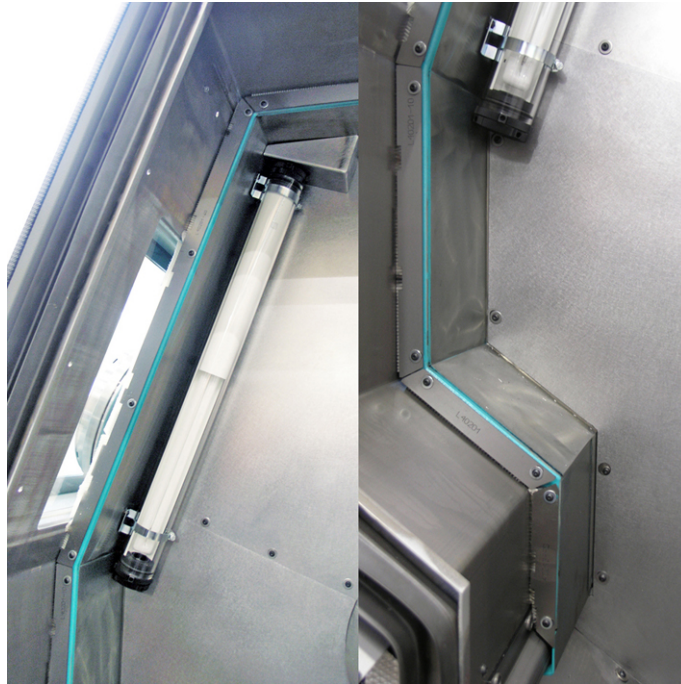

Example: 4 wipers on the sides and bottom, G300

Check the wipers for proper seating. After the work area door has been cleaned, it should open and close again without much effort as usual

5.



If cleaning or replacement of the wipers has not resulted in tangible improvement, the soiled rollers and the guide rail of the work area door must also be cleaned.

Clean rollers and guide rail of the work area door.



## C035 - Check work area door (optionally with electr. drive) and window pane

### Orientation

Inspection and maintenance of the work area door includes several steps:

- Inspection of the window pane for damage.
- Checking the safety label on the window pane (replacement interval 8 years).
- Checking/adjusting or replacing, if necessary, the wipers.
- Check the work area door for smooth opening/closing.
- Check functions of the automatic work area door (optional – electric door drive – **follow manufacturer's documentation from Langer & Laumann** ).

The window pane consists of three panes. The inner pane made of tempered glass, the central pane made of polycarbonate, and the outer pane also made of polycarbonate. The inner pane is relatively resistant. It can be cleaned with any commercially available cleaning agents. Only the center pane is essential for the impact resistance of the window pane.

The polycarbonate panes are subject to **natural** aging and therefore must be subjected to regular visual inspection. Through contact with cooling lubricant, the aging process is accelerated even further.



If the window pane is damaged, it must be replaced. This is necessary regardless of the extent of damage. Even with minimal damage, the impact resistance of the pane can no longer be guaranteed.

Heavily soiled or damaged wipers may cause damage to the inner pane. Moreover, it may be possible that the work area door can be moved only with considerable effort due to heavy soiling or chip deposits in the wipers.

Regularly check and clean the guide rails of the work area door.

Check function of the automatic work area door with electric drive (option like open/close) with different speeds with or without obstacle detection check.

### Requirement



The automatic work area door can be tested only when the machine is switched on and fully functional.

Be sure that the wipers have been checked before testing the automatic work area door. Be sure to remove any chip nests and make sure that the wipers have been cleaned and attached to the plates.

### Procedure

1. Check window pane for damage.

2.  Clean the outer pane with a soft cloth or sponge and glass cleaner or soap and water. Do not use abrasive or alkaline cleaners (e.g., benzene, acetone or carbon tetrachloride) and no sharp tools or sharp objects (such as razor blades or screwdrivers).

Clean outer pane.

3. Clean inner pane.

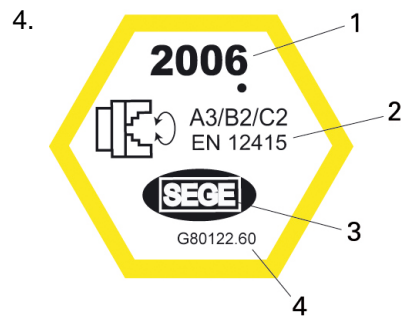

**Example: Safety label – window pane 2006**

- 1 Year of manufacture
- 2 Protection class and EN standard
- 3 Manufacturer
- 4 INDEX part number

Check safety label (replacement interval every 8 years).

5. Check wipers. Remove and clean the wipers. If the wipers are severely deformed or damaged, they must be replaced. To clean the door panels evenly, be sure to reinstall the wipers after their removal aligned in parallel and ensure that they snugly contact the work area door.

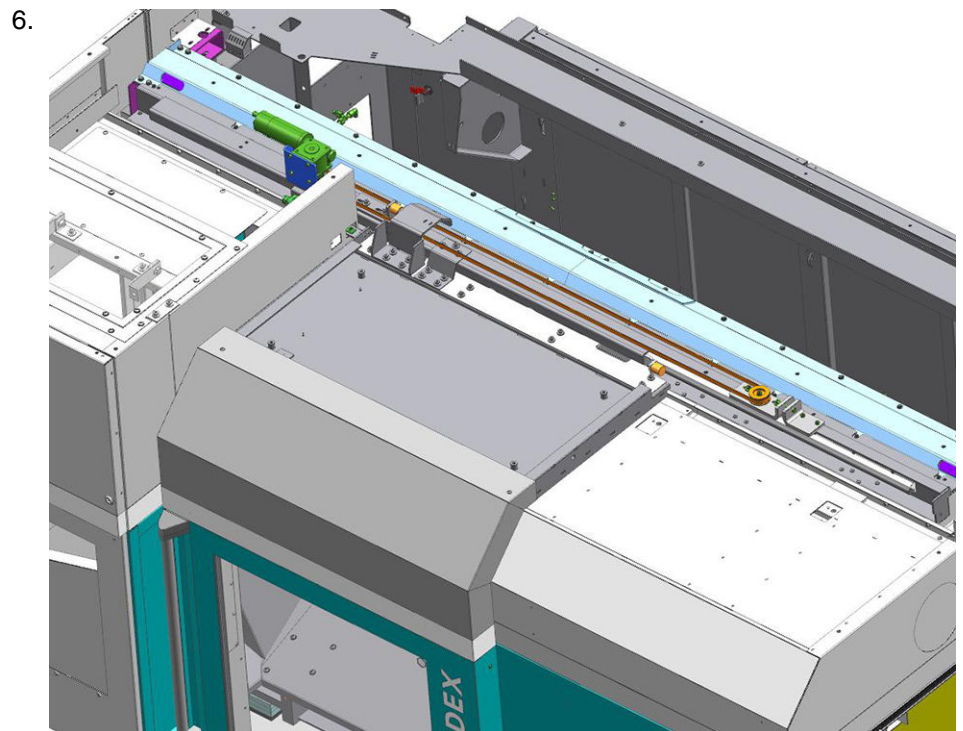

Example: View of the automatic work area door with drive

Check the work area door for ease of movement. To do this, press the emergency stop button and manually open and close the work area door. If the work area door can be moved only with effort, determine the cause. Possible causes are defective or improperly adjusted wipers, or chips on the guide bar or in the guide rollers of the work area door.

7.  **Pinching of limbs due to faulty obstacle detection on the work area door**

Danger

Check obstacle detection.



**INDEX** recommends an annual check of the obstacle detection function of the automatic work area door.

The test should only be carried out with a suitable aid, such as a rectangular strip or a softwood squared timber.

**INDEX** recommends documenting the results of the inspection and keeping them at the workplace.

The machine must be switched on and fully functional for this test.

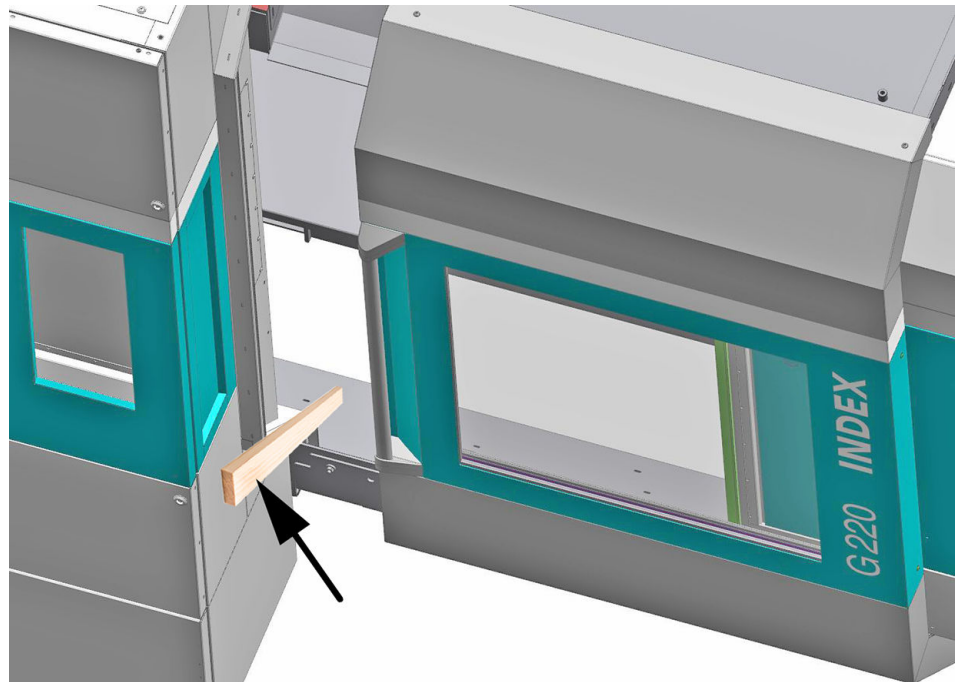

Example: Checking the obstacle detection

Check obstacle detection of the automatic work area door. During the obstacle detection test, a rectangular strip or softwood squared lumber, for example, is held in the travel path of the work area door during the closing process. If the rectangular strip or squared timber comes into contact with the work area door in the closing area, the obstacle detection is triggered and the closing movement must be reversed.

If the obstacle detection does not immediately lead to reversal of the moving direction, the complete work area door must be checked immediately. **The machine must not be operated any further.**

8.



Be sure to contact the **INDEX** service department or an **INDEX** representative.



## C070 - Check outer wipers of linear guides



Carrying out the maintenance activities described below requires special knowledge. For this reason, these maintenance activities must only be carried out by staff that has received adequate training by the machine manufacturer!

### Orientation

Regularly checking wipers of the roller guides prevents accelerated wear of the linear guides. This test is a visual inspection. But if the wiper is destroyed and no longer snugly contacts the contour of the guide, it must be replaced. **It is essential to ensure absolute cleanliness when removing and installing the wiper.**

### Requirement

Move the tool carriers to a suitable position. For checking the outer wipers, parts of the machine enclosure must be removed from the machine. In most cases, access to the wipers is best in the end positions of the respective axes. To move to the positions in which the wipers can be checked, it may be necessary to switch the machine on/off several times.

### Procedure

1. Move the tool carrier to the position required for checking.

2.



Caution

**Moving tool carriers, spindles, or belt drives.**

**Risk of bruising and lacerations.**

Switch off the machine via the main switch or shut down with the emergency stop.

Remove relevant machine enclosure.

3.



Example: Wiper on the trolley of the linear guide (view from the preassembly).

Check wipers.

4. Replace wipers. Loosen and remove the mounting screws of the wiper on the trolley. Push the wiper from the guide bar. Clean the guide bar and push a new wiper onto the guide bar. Finally lightly oil the guideway.

**C080** - Check all electrical connections and drive belts of the drive motors

Carrying out the maintenance activities described below requires special knowledge. For this reason, these maintenance activities must only be carried out by staff that has received adequate training by the machine manufacturer!

**Orientation**

This activity is merely a test to check the power and encoder connections for proper seating and tightness. Simultaneously, all drive belts are subjected to a visual inspection.

**Requirement**

Move the tool carriers to a suitable position.

It may also be necessary to remove various covers or plates for carrying out a visual inspection. Furthermore, a special pair of pliers is needed for tightening the power and encoder connections.



**Example: Special pliers for tightening power and encoder connections on the motors**

**Procedure**

1. Loosen connector and check for corrosion and leaks.
- 2.



If traces of corrosion or moisture are visible, they must be eliminated and their causes must be determined. If the connectors cannot be cleaned, they must be replaced.

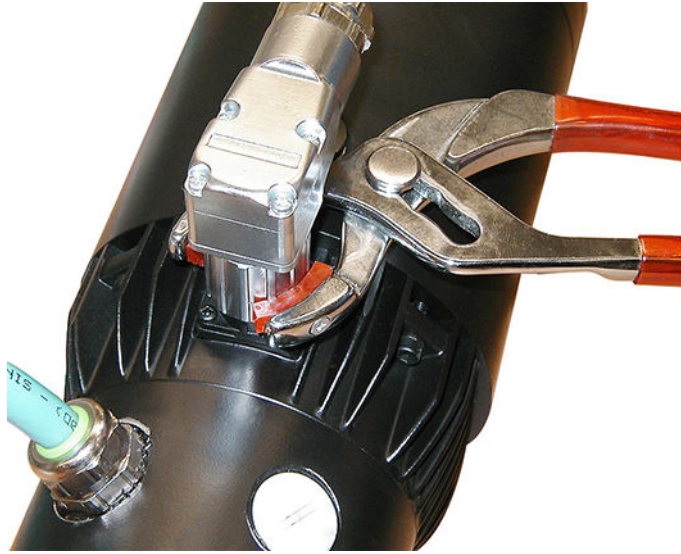

**Example: Tighten motor connector**

When done checking, reconnect plugs and tighten with special pliers (see the example).

3. Check belt on drive motors for any damage or wear.



## C090 - Replace wiper of counter spindle guide in the work area

### Orientation

Due to their open-access location, the counter spindle wipers may be contaminated or impaired by chips particularly hard. Therefore, special attention should be given to the condition of the wipers during servicing and maintenance activities.

### Procedure

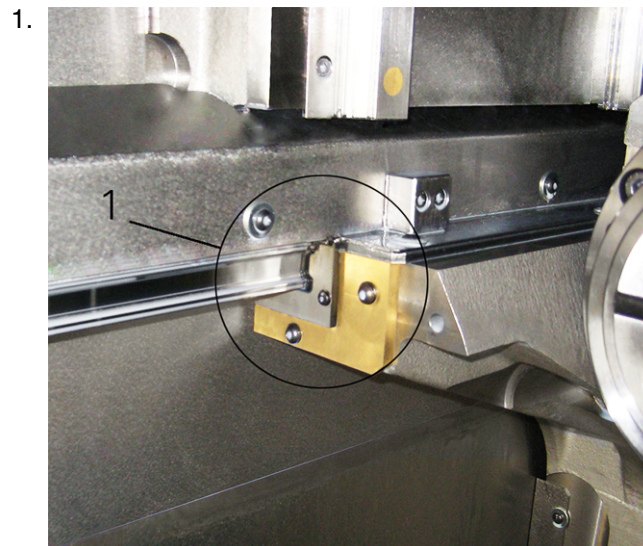

Example: wiper (1) counter spindle C100/C200

Move counter spindle to working position.

2.   
Caution
- Uncontrolled movements of tool carriers or accessories.  
Cuts and crush injuries to hands and arms.**
- Trigger an EMERGENCY STOP on the machine or switch off the machine completely

Check wipers.

**Alternatively, the following procedure can be used!**

Replace wipers, if necessary.

3. Unscrew defective wiper and push to the left of the guide bar. **Be sure to clean the space behind the wiper before inserting the new wiper. Cleaning is essential, otherwise the wiper will again be damaged in the first movement of the counter spindle and the durability of the new wiper will be significantly reduced.**
4. Oil cleaned guide bar so that the wiper can easily be pushed over the guide bar. Slide new wiper carefully onto the guide bar.
5. Slide wiper again to the right up to the contact surface and fasten with the 2x M4 screws. **When securing the new wiper, make sure that the wiper evenly contacts the contour of the gib.**

## C100 - Replace filter on cooling fan of main and counter spindles

### Orientation

The filters must be replaced regularly depending on the ambient conditions.



Whether air flow exists can quickly and easily be made visible by attaching a thread at the opening of the air outlet.



Use only the original filters according to the spare or wear parts list! Otherwise the machine is at risk of sustaining serious damage due to overheating.

### Requirement

A sufficient number of filters must be available.

### Procedure

1. Remove side panels on the main and counter spindles.
2. Remove wire basket over the cooling fan.
3. Replace filter.
4. Clean air hoses of cooling fans. Disconnect air hoses and remove any impurities. Here also clean the air inlet and outlet openings directly on the spindle.
5. Reinstall all covers.

**C130** - Replace filter on air conditioner cooling fan

## Orientation

The filters must be replaced regularly depending on the ambient conditions.



Whether air flow exists can quickly and easily be made visible by attaching a thread at the opening of the air outlet.



Use only the original filters according to the spare or wear parts list! Otherwise the machine is at risk of sustaining serious damage due to overheating.

## Requirement

A sufficient number of filters must be available.

## Procedure

1.



**Example: Filter**

Remove machine covers and/or filter housing cover.

2. Replace filter.
3. Reinstall all covers.

## C140 - Check cooling unit for cooling lubricant



Carrying out the maintenance activities described below requires special knowledge. For this reason, these maintenance activities must only be carried out by staff that has received adequate training by the machine manufacturer!

### Orientation

Water-cooling equipment maintain the temperature in the cooling lubricant circuit on a previously set value. The heat generated by the machining process is dissipated away from the workpiece by the cooling lubricant and the cooling lubricant is cooled down again to the preset temperate by the water cooling unit(s).

To achieve a constant temperature level in this circuit, it is necessary to include it in the inspection and maintenance operations.

Be sure to observe the third-party manufacturer documentation and the technical data of the respective equipment. If in doubt, contact the manufacturer of the equipment or the cooling lubricant vendor.

### Requirement

Prerequisite for effective operation within the cooling circuit is the condition of the cooling lubricant. To check the condition of the cooling lubricant, a refractometer is required. With the help of this instrument, it is possible to determine the concentration of cooling lubricant in water. In addition, the monitoring features available on the cooling unit must be checked or adjusted.

### Procedure

1. General visual inspection for tightness.
2. Check condition of coolant.
3. Check fill level glass(es) (option).
4. Check flow rate sensor and record current values.
5. If necessary, readjust flow rate sensor and record new values.
6. Check temperature sensors/thermostats and record current settings.
7. If necessary, readjust temperature sensors/thermostats and record new values.

## C155 - Check coolant

### Orientation

For add-on equipment that cannot be cooled conventionally with cooling lubricants or hydraulic fluid due to high temperature development, separate cooling is provided in an independent cooling circuit. The coolant used here must be checked continuously for its condition like other coolants.



Apart from this interval, the coolant should generally be replaced once a year.

The system comprises a cooling circuit on the machine side and either

1. a water re cooler located next to the machine or
2. an external cooling circuit provided by the machine operator/owner.



Due to different requirements and/or specifications of the respective manufacturers, be sure to review the respective manufacturer's documentation!



For all work in connection with operating materials, the information in the data sheets of the respective manufacturers and the information in the document **Notes on Operating Materials** must be observed.

### Requirement



Replenish only coolant of the same manufacturer having the same specification. Mixing different coolants may lead to corrosion of the cooling system and degradation of the coolant. Required glycol concentration min. 25%.

When switching the coolant to another product or changing the manufacturer, the cooling system must be completely flushed and cleaned with this coolant. When preparing the coolant from concentrate and water, be sure to use demineralized water only. Only then the machine may be put back into operation.

The machine is filled with Nalco VARIDOS FSK25 at the factory. This water-glycol mixture can be ordered in 25 kg pack sizes from **INDEX**.



When using a water re cooler, be sure to follow the manufacturer's instructions.



Due to different requirements and/or specifications of the respective manufacturers, be sure to review the respective manufacturer's documentation!

## Procedure

1. Check coolant.
2. Check supply and fluid lines for damage such as buckling and abrasions, and for liquid leaks. Replace supply and fluid lines if necessary. Record the age or date of replacement of supply and fluid lines in the service, testing and maintenance schedules or reports.

## C190 - Clean labyrinth rings of spindles

### Orientation



When machining short-chipping materials such as brass, cast iron, or in case of residues from the grinding, the work area must be cleaned more frequently due to the special nature of the contamination. Depending on the duration of use, usage profile of the machine and different ambient conditions, it is necessary in particular to remove and clean the labyrinth rings.



#### **Do not clean the machine with compressed air.**

Raised dirt particles may cause breathing difficulties or injuries (especially of the sensory organs).

Furthermore, raised dirt particles or chips may reach spots where they cause technical problems.



#### **Do not use cotton waste for cleaning.**

When cleaning with cotton waste, fibers or thread can get loose causing safety problems.

### Procedure

1. Loosen and remove the screws on the labyrinth ring (X) of the work spindle. The number of screws that are necessary to fasten the labyrinth ring may differ depending on the type of machine.

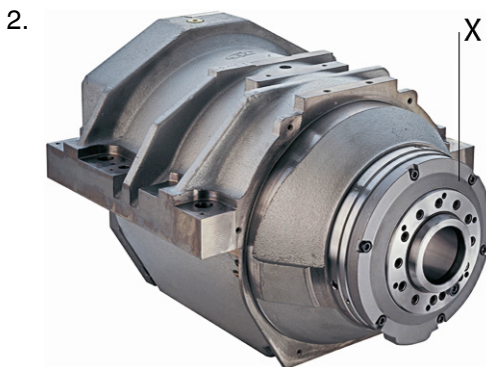

Example: (X) Labyrinth ring on the main spindle G200

Remove the labyrinth ring.

3. Clean the labyrinth ring. Clean the free space behind the labyrinth ring by hand with a cloth.
4. Reinstall the labyrinth ring and tighten the screws to the proper torque.

## C510 - Check backup data carrier

### Orientation

If data from the control is lost, the backup CD/DVD always provides the ability to quickly restore the operation of the machine.

Therefore, regularly checking this data carrier is essential.

### Procedure

1. Check the existing backup data carrier for readability. Insert the data carrier into the appropriate drive of a standard PC.

2.



If the data carrier is not recognized, it is damaged. To create a new backup data carrier, contact the machine manufacturer.

If the data carrier is recognized, make a copy to the hard disk. Create a folder named "Backup Copy" at a suitable location in the directory tree.

3. Copy the entire contents of the backup data carrier to this folder. If the copying process finished without displaying an error message, the data carrier is fine.
4. Delete the folder on your hard disk.



**C520** - Check control cabinet

## Orientation

To avoid problems and prevent any resulting system failures, simplified control cabinet checks must be carried out at regular intervals on the cabinet and associated components. Additional built-in air conditioning units (option) ensure a constant temperature in the control cabinet. These air conditioners cannot work efficiently if filters are dirty or doors are not tight.

## Procedure

-  **Electric shock**  
Power off the machine and wait approx. 30 minutes. Check with a meter if there is still voltage applied to the intermediate circuit.  
  
Check settings of the fuses. For this purpose, review the information in the wiring diagram.
2. Check the screw caps of the fuses for tight seating.
3. Check the screws of drives 611D, terminals, control modules, connectors, bus, device bus and intermediate circuit bus for tightness.
4. Check settings on the air conditioning unit(s) check.
5. Clean suction port(s).
6. Check condensate drain.
7. Check door seals.

## C540 - Check cable and hose clamps for tight seating



Carrying out the maintenance activities described below requires special knowledge. For this reason, these maintenance activities must only be carried out by staff that has received adequate training by the machine manufacturer!

### Orientation

Cable and hose clamps are used to bundle and/or hold the cables and hoses in a certain position.

Loose or faulty clamps can be abrasive to cables or hoses and damage them. Under unfavorable circumstances, defective clamps may lead to “entangling” of the cables/hoses, which may result in tearing off entire bundles.

### Procedure

1. Check cables for chafing and kinks.
2. Check cable and hose clamps for tight seating. In case of moving drags or bundles, check for any movement within the function.

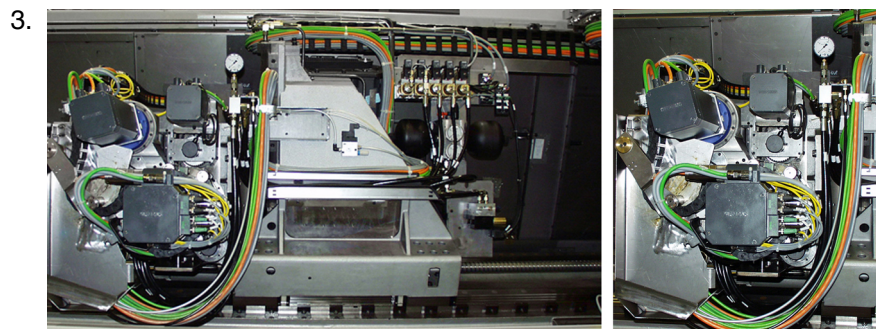

Example: Power cabling, G400

Check strain relief. Check the correct position of the boots and adjust the strain reliefs.

4. Record any damages and initiate repair.

**Service Interval - 4.000 Operating hours**

## Maintenance Summary - 4.000 Operating hours



It is recommended to document the maintenance activities carried out by using the appropriate maintenance log. The maintenance log has the document number LP1602.10101 - 15.08.2022.

- D010** - Cleaning of the machine
- D020** - Check the pressure accumulator
- D050** - Check the lubrication system
- D060** - Check the pneumatic system
- D090** - Check main and counter spindles
- D170** - Check the system for reconditioning the cooling lubricant
- D180** - Check fire extinguishing system (visual inspection)
- D400** - Replacing hydraulic fluid
- D460** - Check blanking plugs of the sliding tracks on the linear guides
- D470** - Check wipers of upper telescopic covers
- D480** - Replace wipers on the trolleys of the linear guides
- D490** - Replacing wipers
- D500** - Perform data backup
- D520** - Check control cabinet and cable assemblies (visual inspection)
- D610** - Check batteries in NC/MMC operating panel on the INDEX C200-4D control and replace if necessary
- D640** - Check setting of electrical fuses

**D010 - Cleaning of the machine****Orientation**

To ensure consistent quality, high availability and value retention, the machine must be regularly cleaned, depending on the operating conditions.

Of course, this is influenced by various factors. The use of emulsion as a cooling lubricant requires a more frequent and intensive cleaning.

Compared to machining producing long chips, machining producing short chips requires a considerably higher maintenance effort. Short chips, such as in the machining of brass or cast iron, form chip accumulations or become deposited in small cracks and corners. These positions must be cleaned regularly to avoid damage to the respective components.

Areas such as telescopic covers, rubber seals, sealing lips or wipers are particularly affected points. Frequent cleaning of these areas is particularly important.

**Requirement**

Only the agents described in the documentation may be used for the cleaning and after-treatment of the machine.

Always use the proper tool to remove chips.

The following tools are required for cleaning:

- chip hooks,
- chip brushes,
- spray bottles of cleaners or cooling lubricant,
- a sufficient quantity of rags,
- oil to apply to the telescopic plates and all other bare parts by spraying or by brushes.

**Procedure**

1.



**Chips and projecting tools in the work area.**

**Cuts.**

Use of personal protective equipment such as safety goggles and gloves, and appropriate tools.

Remove chips from the work area.

2. Chip accumulation particularly in the area of the tool carriers and the work area door.
3. Flush work area with cooling lubricant.
4. Wipe clean with rags.
5. Apply an oil film to bare metal plates and telescopic covers.
6. Check plates for damage, repair or replace if necessary.

7.  When cleaning the drive area, make sure that the dirt does not penetrate directly into the path measuring systems and the ballscrews. The cleaning process must not aggravate the contamination of the components.

Clean drive area. Spray cooling lubricant onto the drive area around the supports of the guide bars and then sweep off the rough dirt down into the drag of the machine with a hand brush. Afterwards rub with rags.

8.  When cleaning the spindle carriers, make sure that the dirt does not penetrate directly into the spindle encoders. The cleaning process must not aggravate the contamination of the components. Follow the manufacturer's documentation.

Cleaning of the spindle carriers of the main and counter spindles. Remove machine covers in the area of the spindles. Then remove and clean the spindle covers.

9. Clean the machine base. Remove accumulations of chips, especially in the area of the counter spindle. For this purpose, move the counter spindle towards the main spindle and flush the area with cooling lubricant in the direction of the chip conveyor. Sweep the dirt arising from the cleaning of the drive area also in the direction of the chip conveyor and then flush with cooling lubricant. Afterwards rub with rags.
10. Clean and reinstall machine covers.
11. Clean the collecting tray under the workpiece handling unit.

## D020 - Check the pressure accumulator

### Orientation

A pressure accumulator consists of two chambers, a liquid and a gas section with a membrane as a separator. The liquid section is connected to the hydraulic circuit, so that the bubble reservoir is filled when the pressure rises, thereby compressing the gas. When the pressure drops, the compressed gas expands and displaces the stored pressurized liquid into the circulation. This ensures that the pressure level is maintained during load changes or temporary higher loads.



Screws on the hydraulic system, the connected components, and the supply lines must be tightened to the manufacturer's specified torques.

### Procedure

1. Check the pressure accumulator. With the machine powered on (not during the program or continuous run), slowly open the accumulator drain valve on the hydraulic fluid tank and watch the needle on the system pressure gauge.

The pressure gauge needle slowly falls to a point where it quickly drops to zero. This point is the approximate accumulator bias tension. This value is 50 +/-2 bar. **If this value is below 40 bar, the pressure accumulator must be replaced.**

## D050 - Check the lubrication system

### Orientation



Due to different requirements and/or specifications of the respective manufacturers, be sure to review the respective manufacturer's documentation!

The principle of open lubrication requires refilling of lubricating oil.

During maintenance of the lubrication system, first perform a visual inspection of all components involved in lubrication for leaks and their visual condition. The following components must be examined during maintenance of the lubricating oil system:

- Lubricating oil tank
- Oil level in lubricating oil tank
- Lubricating oil pump
- Supply and fluid lines
- Pressure gauges
- Metering valves
- Pressure sensors



For all work in connection with operating materials, the information in the data sheets of the respective manufacturers and the information in the document **Notes on Operating Materials** must be observed.



Screws on the lubrication system, the connected components, and the supply lines must be tightened to the manufacturer's specified torques.

### Requirement

The maintenance of the lubricating oil supply requires the following auxiliary or working equipment:

- Use an ample supply of cleaning rags.
- A sufficient amount of lubricating oil for refilling/changing.
- Replacement filters for lubricating oil tank.



Oil type, specification and quantity as specified in the technical data.



Use only the original filters according to the spare or wear parts list!



Service and maintenance are to be carried out according to the manufacturer's specifications.



## Procedure

1.  **Pressurized fluids exiting from damaged or incorrectly installed fluid lines.**  
**General cuts or eye injuries.**  
Power off the machine and depressurize the hydraulic system before any maintenance activities. Secure the machine against being switched on. Wear personal protective equipment.  
Check supply and fluid lines (damage and leakage). Supply and fluid lines must be checked for damage. Pre-damage such as kinks or abrasions should be logged and replacement should be initiated.
2. Check lubrication pressure and related sensors.
3. Activate lubrication pulse in the control ten times.
4. Monitor the area around the lubricating oil distributor for leakage.

## D060 - Check the pneumatic system

### Orientation

The pneumatic system is composed of two components. The system section and the sealing air section (option). To ensure trouble-free operation, periodic checks of the pneumatic system are necessary.

- Check oil level at oiler (optional).
- Check fluid lines.
- Check silencers.
- Replace filter.
- Drain condensate (not applicable to auto-drain).
- Check the pressure settings on the pressure gauges (system and sealing air).



Due to different requirements and/or specifications of the respective manufacturers, be sure to review the respective manufacturer's documentation!

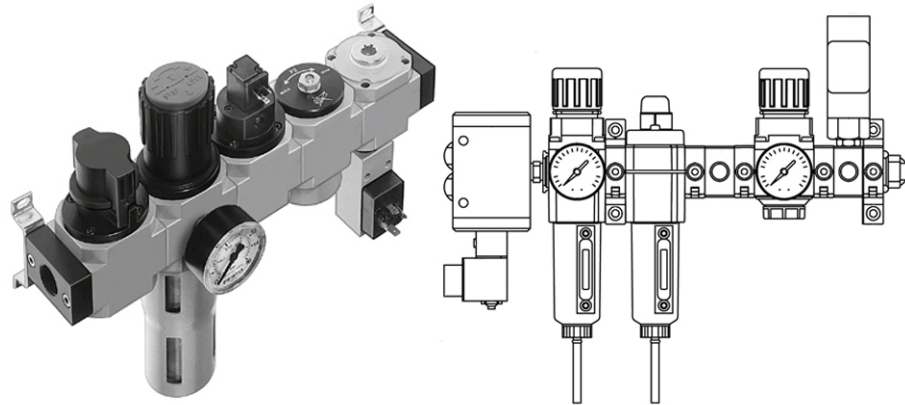

Example: Pneumatic maintenance unit by Festo/ Norgren

### Procedure

1.



Power off the machine to depressurize the pneumatic system and secure against accidental switching on.

Check oil level at oiler (optional).

2. Check supply and fluid lines (damage and leakage). Supply and fluid lines must be checked for damage. Pre-damage such as kinks or abrasions should be logged and replacement should be initiated.



Example: Various silencer versions from FESTO/ Norgren

Check silencer, replace if necessary.

- 4.
-  Dirty filter cartridges must never be cleaned but always replaced. Filter cartridges are hazardous waste and must be disposed of according to local regulations.

Only filters with a filter fineness described in the fluid plans must be used.

Replace filter.

- 5.
-  Condensate is extremely harmful to the environment due to its high pollution impact. Condensate must be collected in a container specifically marked for this purpose and properly disposed of.

Drain condensate (not applicable to auto-drain).

6. Switch on the machine.
7. Check the pressure setting on the system pressure gauge and adjust if necessary. A pressure of 6 bar has been set at the factory.

- 8.
-  Dirty measuring systems or lack of sealing air can cause damage to the machine.

Check sealing air supply. To protect measuring systems or other components from the ingress of liquids or dirt, they are pressurized (0.6 bar). In this case, a low hiss is noticeable. To ensure trouble-free operation, periodic checks of the sealing air supply are necessary.

9. Check all fluid lines of the sealing air supply for damage.
10. Check the pressure setting on the sealing air pressure gauge and adjust if necessary. A pressure of 0.6 bar has been set at the factory.
11. Check sealing air supply on the components. A reliable method is the use of a suitable pressure gauge. The pressure gauge is attached to the line that is screwed off to monitor the existing pressure. The pressure should be in the range of the preset pressure of the sealing air supply. If this is not the case, the cause must be determined and the fault must be fixed.

**Alternatively, the following procedure can be used!**

Disconnect the fluid line in the area of the components and cover the opening of the fluid line with your finger. A slight counter pressure should be felt. Then connect the fluid line again.

## D090 - Check main and counter spindles



Carrying out the maintenance activities described below requires special knowledge. For this reason, these maintenance activities must only be carried out by staff that has received adequate training by the machine manufacturer!

## Orientation

Checking the main and counter spindles also includes other, additional activities. They should be carried out now, because various different plates and/or covers must be removed to facilitate access to other components, thus allowing other activities.

- Clean labyrinth rings and space behind the rings.
- Clean the encoder wheels.
- Visual inspection of the hydraulic accessory units. Check aligning and indexing units, clamping cylinder for leaks.
- Check supply and exhaust pipes on the main and counter spindles.
- Check filters on the air supply to the spindles.
- Check cooling lubricant and stopper unit with cooling lubricant rotary distributor.
- Check aligning and indexing units.
- Check O-rings on the clamping devices, replace if necessary

## Procedure

1. Remove machine enclosure in the area of the spindles

- 2.



Caution

**Sharp edges on cover.**

**Cuts.**

Wear personal protective equipment.

Remove cover over the spindles on the clamping cylinder.

- 3.

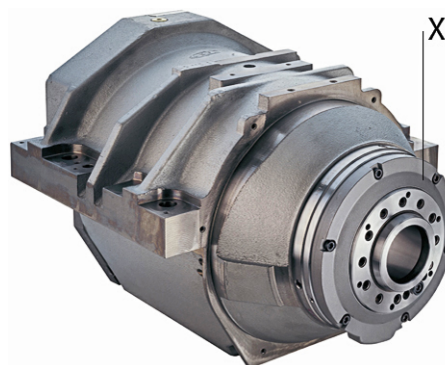

Example: Labyrinth ring (X) on the main spindle, G-machine

Clean the space behind the labyrinth rings (X) with rags.

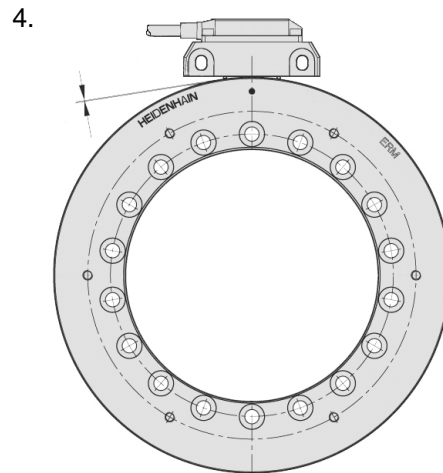

**Example: Encoder wheel Heidenhain ERM**

Clean encoder wheels. **Do not use any metal tools or objects for cleaning.** To ensure optimum data exchange between the encoder and the encoder wheel, the encoder wheel must be cleaned regularly. Ensure absolute cleanliness, so that the cleaning does not lead to additional contamination of the encoder wheel or the encoder.

5. Check the tightness of the hydraulic accessory units. Check the aligning and indexing units, solid or hollow clamping cylinders for leaks.
6. Check supply and exhaust pipes on the main and counter spindles. Defective intake and exhaust air pipes on the main and counter spindles may cause overheating and thus damage to the spindles.

7.  Whether air flow exists can quickly and easily be made visible by attaching a thread at the opening of the air outlet.

Check filters on the air supply to the spindles. The use of dirty or incorrect filter mats at the air intake can also lead to overheating and thus to damage to the spindles. Be sure to use only original filters.

8.

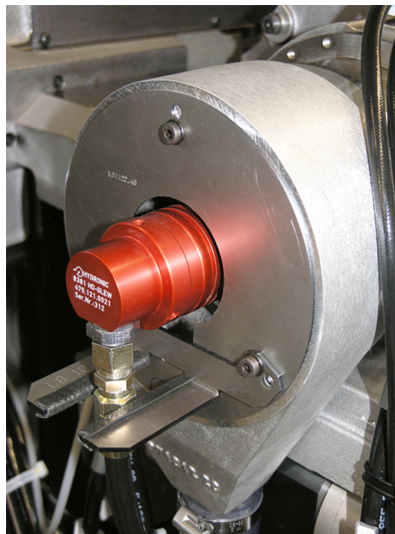

**Example: Cooling lubricant rotary distributor (e.g., from Hydronic)**

Check cooling lubricant distributor rotary distributor. Detach the cooling lubricant rotary distributor and check that cooling lubricant flows out. Cooling lubricant should escape from the rotary distributor when the machine and cooling lubricant pump are switched on and the work area door is closed.

9.

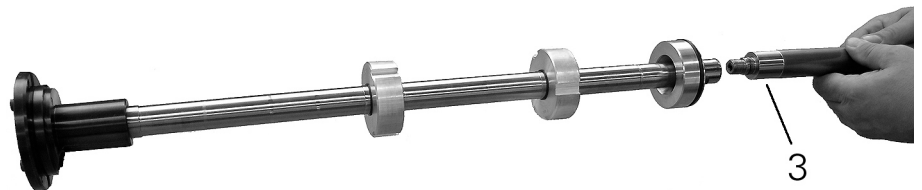

**Example: Remove bar stop**

Remove bar stop (3).

10.

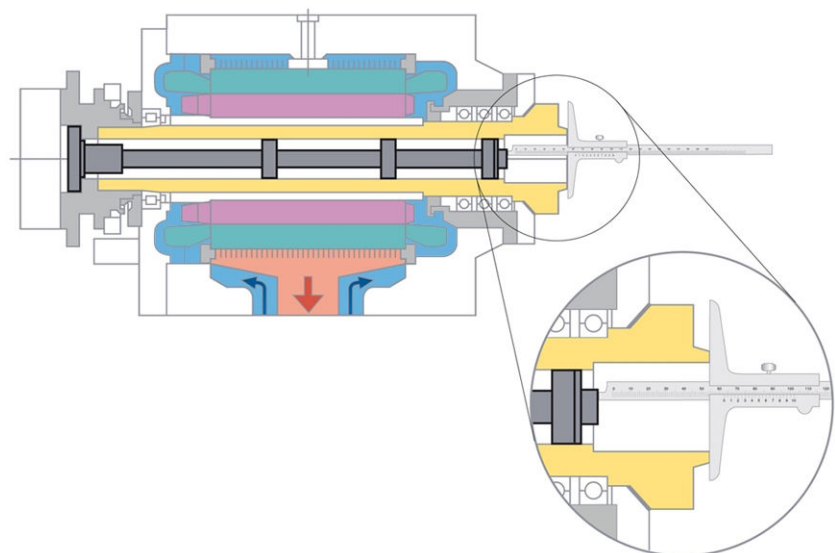

**Example: Measure the installation size of the stopper unit**

Measure the installation size of the stopper unit (1) and the guide ring (2) and record the values.

11.

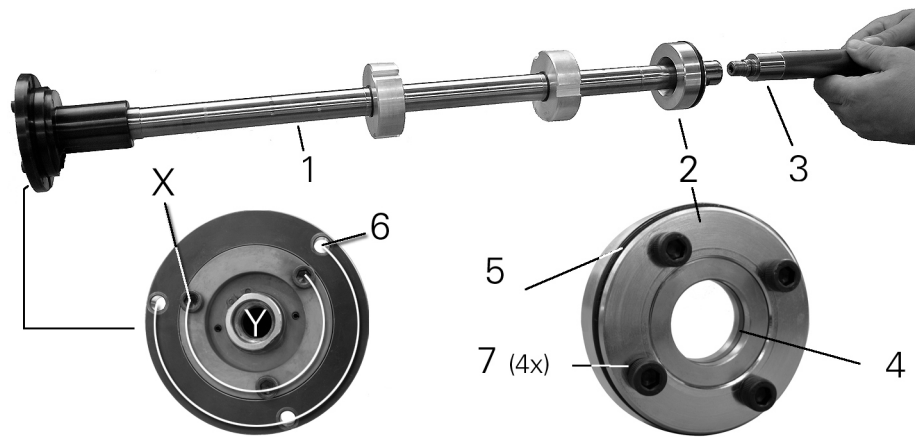

Example: Stopper unit D42

Remove cooling lubricant and stopper unit. Loosen screws (6) and pull the cooling lubricant and stopper unit (1) out of the spindle from the back. The guide ring (2) has an O-ring (5) at its outside with which the spindle is sealed towards the work area and a Glyd ring (4) inside that is used to guide the cooling lubricant and stopper unit in the spindle.

12. Check O-ring (5), replace if necessary. To check the O-ring (5), loosen the screws (7) of the guide ring (2) and remove the guide ring (2) from the spindle. Check O-ring, replace if necessary. If necessary, insert a new O-ring, grease, and tighten the screws (7) lightly.
13. Check Glyd ring (4), replace if necessary. To replace the Glyd ring, lift it carefully with a small screwdriver in the recess, taking care not to damage the recess, and remove the Glyd ring. Grease the new Glyd ring and insert it into the recess. Carefully precalibrate the Glyd ring in the guide ring (2), using the cooling lubricant and stopper unit (1). After a few minutes, remove the guide ring (2) from the cooling lubricant and stopper unit (1).
14. Reinstall the cooling lubricant and stopper unit (1), securing it with the screws (6). Then position the cooling lubricant and stopper unit (1) according to the setting value. Use the two-flat (Y) for the adjustment. Then tighten the screws (X).
15. Insert guide ring (2) into the spindle from the front, position it according to the setting value and retighten the screws (7).
16. Screw in and tighten the bar stop (3).
17. Reattach the cooling lubricant rotary distributor.

18.



**Do not** reinstall any existing screen in the draining outlet of the clamping cylinder. The screen may clog to the extent that the cooling lubricant dams up so that it can enter the hydraulic fluid circuit via the clamping cylinder.



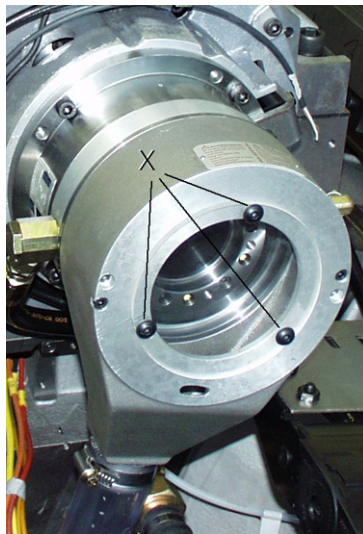

**Example: Cooling lubricant outlet on the clamping cylinder**

X Screws on the acrylic glass cover

Check the cooling lubricant drain on the clamping cylinder. Check that the drain is free and contains no chips. Loosen screws (X) and remove acrylic glass cover on the cooling lubricant drain of the clamping cylinder. Remove chips or other impurities and ensure that the cooling lubricant can drain off.

19. Check the aligning and indexing units for function and tightness. By repeated pressing of the **Softkey** Lock/Unlock in **Softkey** Operate Units . **Softkey** Spindles – Select spindle Sx – Enter speed, e.g., 100, and position, e.g., 0 deg. **Softkey** Position – **Softkey** Lock – Monitor the setup to see whether hydraulic fluid flows out.

20.



Due to different requirements and/or specifications of the respective manufacturers, be sure to review the respective manufacturer's documentation!

Check and potentially replace O-rings or other seals on the clamping devices. O-rings and other seals on the clamping devices prevent that chips or cooling lubricant penetrate into the hydraulic circuit or even into the mechanical components of the respective assemblies where they can cause significant damage. In any case, make sure that the seals recommended by the manufacturer are used or installed during maintenance or repair work.

## D170 - Check the system for reconditioning the cooling lubricant

### Orientation

Cooling and cleaning equipment for cooling lubricants is used where reconditioning of the cooling lubricant is necessary. Here, in order to achieve high availability of the cooling lubricant, the cooling lubricant is filtered (e.g., using edge gap filters or vacuum rotation filters) and also cooled using coolers to a certain preset temperature.

Here, the filters, pressure and temperature sensors, valve functions and fluid lines of the devices must be checked.

Similarly, the supply lines to the machine and the fluid lines in the machine must be checked for damage such as abrasions or kinks or leakage.



For all work in connection with operating materials, the information in the data sheets of the respective manufacturers and the information in the document **Notes on Operating Materials** must be observed.



Due to different requirements and/or specifications of the respective manufacturers, be sure to review the respective manufacturer's documentation!

### Requirement

To determine the concentration of cooling lubricant in the cooling lubricant, a measuring device (refractometer) is necessary.

### Procedure

1. Evaluate the overall impression of the system.
2. Visual inspection for leaks.
- 3.



Filters are hazardous waste and must be disposed of in a controlled manner.

Replace filter.

4. Check and potentially adjust float switch settings.
5. Check and potentially adjust temperature sensor settings.
6. Check and potentially adjust pressure sensor settings.

## D180 - Check fire extinguishing system (visual inspection)

## Orientation



An examination of a fire extinguishing system may only be conducted directly by the manufacturer or a person with written authorization by the manufacturer.

Be sure to read the operating instructions of the manufacturer!

## Procedure

1. Visual inspection for obvious defects.
- 2.



Example: Inspection stickers Kraft & Bauer

Check sticker for manufacturing date.

3. Check sticker for inspection date.
4. Check sticker for battery replacement.

## D400 - Replacing hydraulic fluid

### Orientation



Power off the machine and secure it against power on.



Use only approved hydraulic fluid. Details can be found in the documentation and on the label of the hydraulic fluid tank.

When changing the type of hydraulic fluid, the unit must be flushed with new fluid.



For all work in connection with operating materials, the information in the data sheets of the respective manufacturers and the information in the document **Notes on Operating Materials** must be observed.

### Requirement



Specification and quantity of hydraulic fluid as specified in the technical data.

Before replacing the hydraulic fluid, make sure that the required spare parts such as seals and filters are available.



Use only the original filters according to the spare or wear parts list.

### Procedure

1. Extract old fluid through the filler neck (a) or drain the fluid from the drain plug (d) below the fill-level glass (c). Use a suitable collection bin for this purpose.

2.



Use only lint-free cleaning cloths or a sponge!

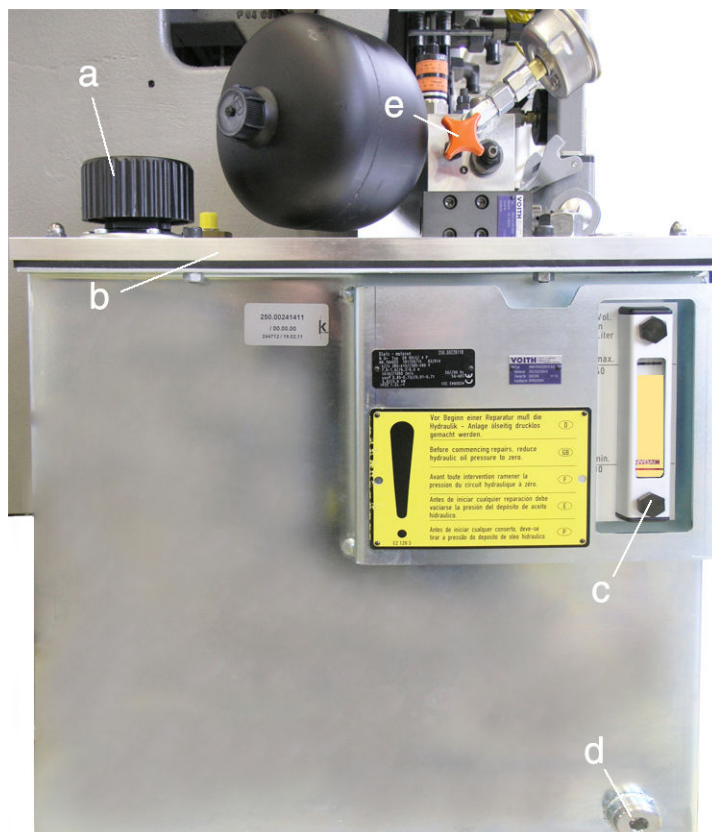

Hydraulic unit C100 C200 C200tandem

- a Filler neck
- b Base plate of hydraulic system
- c Fill-level check
- d Drain plug
- e Accumulator drain valve

Remove the hydraulic system base plate (b) and clean the hydraulic fluid tank.

3. Replace the seal at the hydraulic system base plate (b).
4. Screw on the hydraulic system base plate (b) again, paying attention to the correct seating of the seal and the base plate (b).

5.  Dispose of the fluid in the filter bowl (Y); do **not** refill into the hydraulic tank.



Hydraulic filter conveyor C100/C200 C200tandem

Replace filters (Z) of the hydraulic fluid filters (X). A different number of hydraulic filters (X) may be installed, depending on the version. Unscrew filter bowl (Y), remove contaminated hydraulic fluid (oil sump) and used filter (Z) from the filter bowl (Y) and dispose of them according to environmental regulations.

6.



Only filters with retained particle sizes described in the fluid plans must be used.



Z

Example: Filter (Z)

Clean filter bowl (Y) and insert a new filter (Z). Reinstall the filter bowl (Y) and tighten **by hand until it stops**. Then back off the filter bowl (Y) 1/8 turn.

7. To fill in new hydraulic fluid, use a pump with a min. 10 µm micro filter that is exclusively used for hydraulic fluid.
8. Fill in the prescribed amount of new hydraulic fluid.
9. Switch on the machine and hydraulic system.
10. Check and, if necessary, replenish hydraulic fluid level.

11. Vent hydraulic system. To bleed the hydraulic system, open the accumulator drain valve (s) for approx. 10 seconds and then close it again.

## D460 - Check blanking plugs of the sliding tracks on the linear guides

### Orientation

When mounting the guide bars, align the screw holes of the guide bar and then close them with a brass plug and sand them off. This will prevent damages from sharp edges to the wipers of the tool slides.

After some time (depending on the usage profile of the machine and the maintenance and cleaning intervals carried out), these blanking plugs show signs of wear and must be replaced.

### Requirement

Move the tool slides to a suitable position.

To replace the blanking plugs on the guide bars, the following utilities and tools are needed:

- small hand drill,
- drill bits of various diameters and taps in various sizes,
- pin puller,
- sanding screen and a fine oil stone (-> Arkansas oil stone),
- small straight-edge.

### Procedure

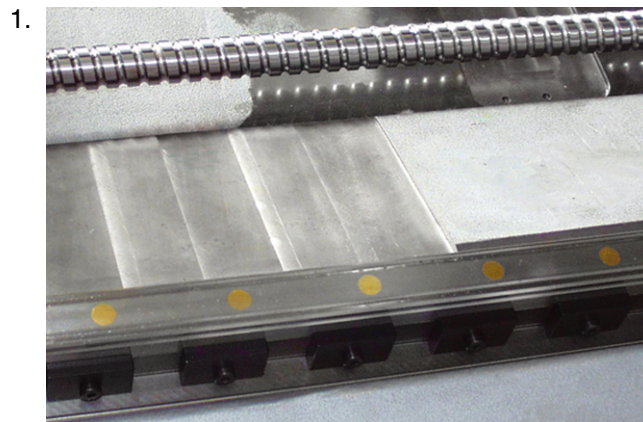

Example: Blanking plug for Z1 axis linear guide, G200

Check blanking plug of linear guides.

2. Replace the blanking plugs. To remove the blanking plugs, drill a hole into the blanking plugs and tap a thread. Then pull out the blanking plug with the pin puller.



3.

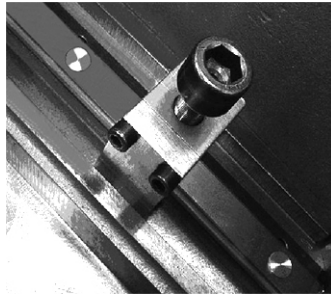

Punch the new blanking plug into the hole using a plastic mallet.

4. Grind off any excess material with the sanding screen. Be careful that the guide bar is not damaged.
5. Check with the straight edge that the blanking plugs are flush with the linear guide and no longer protrude. This must be ensured to prevent damage to the wipers.

## D470 - Check wipers of upper telescopic covers

### Orientation

Depending on the material used and the machining process, the telescopic cover must be cleaned and checked regularly. In particular, before any prolonged shutdown of the machine (e.g., during weekends). Cover sheets (static) and telescopic covers (dynamic) are attached to protect the drive area (ballscrews, drive motors, etc.) from contamination. Since the telescopic covers and wipers are constantly in motion and also exposed to heavy pollution by the machining, they must be regularly cleaned and oiled.

Always use the proper tool to remove chips.



After cleaning, the telescopic cover must be coated with low-viscosity oil.

The oil must not resinify and sediments must not form when exposed to other fluids or machining residues (e.g., metallic dust). Otherwise, the service life of the wipers would be considerably impaired.

### Requirement



Example: Tool for removing chips

### Procedure

1. Clean the machine work area.
2. Clean telescopic covers.
3. Check wipers and replace if necessary.
4. Oil the telescopic covers.

## D480 - Replace wipers on the trolleys of the linear guides



Carrying out the maintenance activities described below requires special knowledge. For this reason, these maintenance activities must only be carried out by staff that has received adequate training by the machine manufacturer!

### Orientation

The wipers on the trolleys of the linear guides prevent the ingress of dirt into the ballscrew. The outer wipers of the trolleys are easily accessible and thus can be replaced quickly. It is also possible to push out the entire trolley under the tool slide to replace the two wipers. Damaged guide bars may have a negative effect on the machining result of the lathe or on the surface of the workpieces.

### Procedure

1. Move the tool slide to an appropriate position.
2. Replace outer wipers. Loosen screws of wipers accessible from the outside and remove the wipers. Replace wipers.

#### **Alternatively, the following procedure can be used!**

Replace external and internal wipers. Loosen and remove screws of the accessible trolley. Always remove one trolley and replace one wiper after the other.

3.



Do not push trolley from the guide bar. Balls of the linear ball bearing may be lost.

Push out trolley carefully under the tool slide.

4.



New wipers must rest against the contour of the guide bar.

Replace inner and outer wipers.

5. Push the trolley back under the tool slide and tighten the screws.

## D490 - Replacing wipers

### Orientation



Regular inspection of the wipers prevents damage to the wipers themselves and to the work area door.

If the work area door can be opened and/or closed only with increased effort, it can be expected that the wipers are already destroyed by accumulation of chips and swarf compaction.

### Requirement



Example: Chip hook and chip brush

Use appropriate tools to remove coarse chips, chip nests and other debris.

### Procedure



Example: 1 Removing chip nest using appropriate tools (e.g., chip hooks)

Remove large chips on the inside of the work area door from top to bottom. Use a chip hook for this purpose.



Example: 2 Sweep small chips and other debris from top to bottom using chip brooms or brushes.

Remove small chips and chip accumulations on the inside of the work area door from top to bottom. Use a chip brush for this purpose.

3. Clean the area behind the wipers.

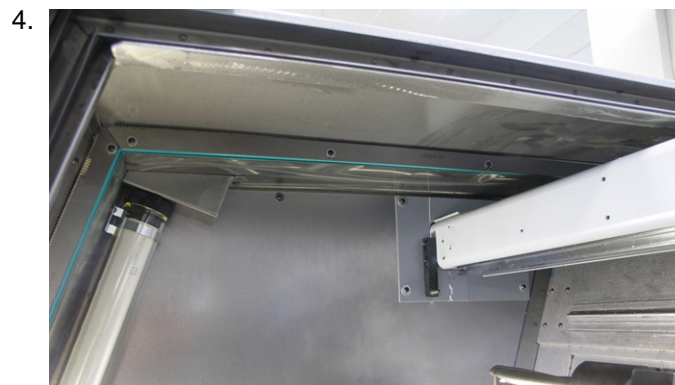

Example: 3 upper wipers, G300

Replace wipers. Depending on the version or design of the machine, plastic or metal wipers are installed. Plastic wipers need to be replaced every 4000h while metal wipers only need to be replaced as needed.

5.  Make sure that the wipers evenly contact the work area door before tightening the screws.

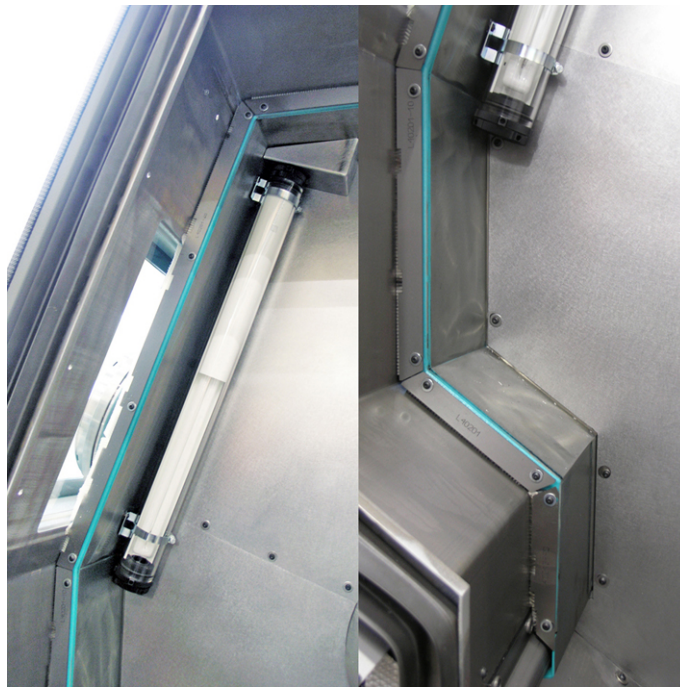

Example: 4 wipers on the sides and bottom, G300

Check the wipers for proper seating. After the wipers have been replaced, the work area door should open and close again without much effort as usual

6.



If replacement of the wipers has not resulted in tangible improvement, the soiled rollers and the guide rail of the work area door must also be cleaned.

Clean rollers and guide rail of the work area door.

## D500 - Perform data backup



Carrying out the maintenance activities described below requires special knowledge. For this reason, these maintenance activities must only be carried out by staff that has received adequate training by the machine manufacturer!

### Orientation

If data from the control is lost, the backup CD/DVD always provides the ability to quickly restore the operation of the machine. If machine data have been modified as part of maintenance or repair work, a data backup **must** be performed. In this case, a backup of the PLC and NC archives is sufficient. The data can be saved to a floppy disk or USB flash drive, depending on the machine control equipment. In a system recovery, the backup CD/DVD created when the machine was delivered is restored on the machine. Afterwards, the PLC and NC archive files are loaded from the floppy disk or USB flash drive.

### Procedure

1. Perform data backup.

## D520 - Check control cabinet and cable assemblies (visual inspection)



Carrying out the maintenance activities described below requires special knowledge. For this reason, these maintenance activities must only be carried out by staff that has received adequate training by the machine manufacturer!

### Orientation

To avoid problems and prevent any resulting system failures, simplified control cabinet checks must be carried out at regular intervals on the cabinet and associated components. This include a visual inspection of the wire harnesses of the individual modules and the grounding cable. Additional built-in air conditioning units (option) ensure a constant temperature in the control cabinet. These air conditioners cannot work efficiently if filters are dirty or doors are not tight.



Use only the original filters according to the spare or wear parts list!

Filters are hazardous waste and must be disposed of in accordance with environmental guidelines and regulations of the country of operation.

When working in or on the control cabinet, switch off the machine and secure it against power on.

### Requirement



Even with the machine powered off, some devices or components in the control cabinet are still energized.



Observe the specific electrical diagrams for this machine.

### Procedure

1. Switch off the machine.
2. Have the electrical diagrams for the corresponding machine ready.
3. Replace all filters on the control cabinet and cabinet components.
4. Check that the cabinet doors can be properly closed. If the cabinet doors can not be closed properly, determine the cause and eliminate it. Possible causes could be faulty seals, hinges, or even a damaged cabinet door.
5. Check all cabinet seals. They should be free of oil and condensation.
6. Clean the control cabinet. Use a suitable vacuum cleaner for this purpose.
7. Check the cabinet lighting (optional).



8. Check grounding cable. Grounding cables are located, e.g., between the control cabinet and cabinet doors and between the base and the machine bed.
9. Check cable assemblies for damage, replace if necessary.

**D610** - Check batteries in NC/MMC operating panel on the INDEX C200-4D control and replace if necessary



Carrying out the maintenance activities described below requires special knowledge. For this reason, these maintenance activities must only be carried out by staff that has received adequate training by the machine manufacturer!

## Orientation

Different types of batteries are installed at various positions of the machine. They fulfill various tasks. These batteries must be replaced at certain intervals. For the exact replacement intervals, see the “Battery Replacement Intervals” label inside the operating panel.



Be sure to obtain the exact number of batteries and their style or type from the respective manufacturer documentation.

INDEX	
Tauschdatum	Batterie in der Bedienfeld-Steuerung - Intervall 3 Jahre
Date of replacement	Battery in the control operating panel - interval 3 years
Date de remplacement	Pile dans la commande du tableau de commande - intervalle de 3 ans
Data di sostituzione	Batteria nell'unità di controllo del quadro comandi - Intervallo 3 anni
Byesdatum	Batteri i mandoverpanel-styring - intervall 3 år
Fecha de sustitución	Bateria del control del panel de mando - intervalo: 3 años
Data da troca	Bateria no comando da área de operação - intervalo de 3 anos
Vaihtopäivä	Ohjauksen käyttöpaneelin paristo - vaihtoväli 3 vuotta
Datum výměny	Baterie v řízení ovládacího panelu - interval 3 roky
Data wymiany	Bateria w sterowniku panelu operatora - co 3 lata
Data schimbării	Bateria din unitatea de comandă a panoului de operare - interval 3 ani
Csere dátuma	Közelítőit vezérlésnek akkua - lökököz 3 év
Vervangingsdatum	Batterij in de bedieningspaneelbesturing - interval 3 jaar
Udskifningsdato	Batteri i betjeningfelt-styring - interval 3 år
Tauschdatum	Batterie in der Maschinensteuerung - Intervall 3 Jahre
Date of replacement	Battery in the machine control - interval 3 years
Date de remplacement	Pile dans la commande de la machine - intervalle de 3 ans
Data di sostituzione	Batteria nell'unità di controllo della macchina - Intervallo 3 anni
Byesdatum	Batteri i maskinstyringen - intervall 3 år
Fecha de sustitución	Bateria del control de la máquina - intervalo: 3 años
Data da troca	Bateria no comando da máquina - intervalo de 3 anos
Vaihtopäivä	Koneen käyttöpaneelin paristo - vaihtoväli 3 vuotta
Datum výměny	Baterie v řízení stroje - interval 3 roky
Data wymiany	Bateria w sterowniku maszyny - co 3 lata
Data schimbării	Bateria din unitatea de comandă a mașinii - interval 3 ani
Csere dátuma	Gépvvezérlés akkua - lökököz 3 év
Vervangingsdatum	Batterij in de machinebesturing - interval 3 jaar
Udskifningsdato	Batteri i maskinstyringen - interval 3 år
Tauschdatum	Batterie auf der Steckkarte der Fa. ARTIS - Intervall 3 Jahre
Date of replacement	Battery on the ARTIS plug-in card - interval 3 years
Date de remplacement	Pile sur la carte d'extension de la société ARTIS - intervalle de 3 ans
Data di sostituzione	Batteria nella scheda della ditta ARTIS - Intervallo 3 anni
Byesdatum	Batteri i stickkort från ARTIS - intervall 3 år
Fecha de sustitución	Bateria en la tarjeta enchufable de ARTIS - intervalo: 3 años
Data da troca	Bateria na placa de firma ARTIS - intervalo de 3 anos
Vaihtopäivä	ARTIS-yhtön liitännäkortissa oleva paristo - vaihtoväli 3 vuotta
Datum výměny	Baterie na rozšiřující kartě ty ARTIS - interval 3 roky
Data wymiany	Bateria na kartce firmy ARTIS - co 3 lata
Data schimbării	Bateria de pe placa de extensie a firmei ARTIS - interval 3 ani
Csere dátuma	ARTIS bővítlőkártya akkua - lökököz 3 év
Vervangingsdatum	Batterij op de insteekkaart van de fa. ARTIS - interval 3 jaar
Udskifningsdato	Batteri på printkort firma ARTIS - interval 3 år

Label for battery replacement intervals

## Requirement



Power off the machine and secure it against power on.

Before replacing the batteries, make sure that spare batteries are at hand. The change process must be completed within a specified time, otherwise data may be

lost. For the exact buffering time, see the respective manufacturer's user documentation.

## Procedure

1.  **Even after switching off all power supplies, dangerous voltage continues to be applied to all modules for 30 minutes!**

Caution

**Therefore, improper use of these devices can result in death, serious injury or substantial property damage.**

Servicing of this device may be performed only by appropriately qualified personnel. Switch off the machine and lock it out. Check with a meter if there is still voltage applied to the intermediate circuit rail.



The next steps must be performed within 15 minutes, otherwise data loss is imminent.

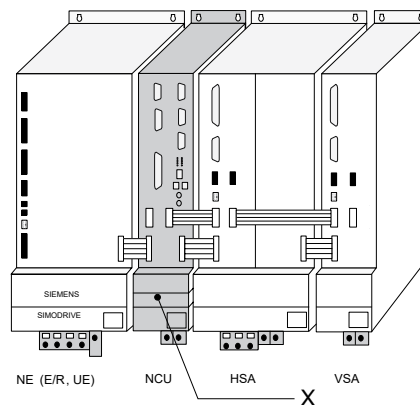

**Example: NCU CPU C200-4D battery drawer**

X Fan and battery compartment

Replace complete fan assembly (including battery). Unlock the fan insert on the bottom (3) and pull it out.

2. Push new fan insert in until it clicks into place. Indicate the date of the next interval with the appropriate inspection sticker on the battery interval label.

3.  The next steps must be performed within 15 minutes, otherwise data loss is imminent.

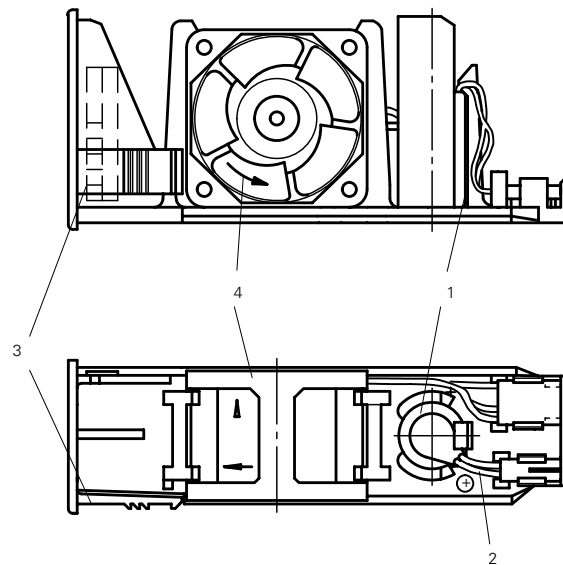

**Example: Battery with NCU fan – Control C200-4D.**

- 1 Battery
- 2 Red wire
- 3 Latch
- 4 Fan

Replace NCU battery. Unlock the fan insert on the bottom (3) and pull it out. Remove the battery connector by slightly pushing the retaining latches outwards. Replace battery. **Make sure of the correct polarity (red = +) when installing the battery.** Reconnect the battery plug.

4. Push fan insert in until it clicks into place. Indicate the date of the next interval with the appropriate inspection sticker on the battery interval label.

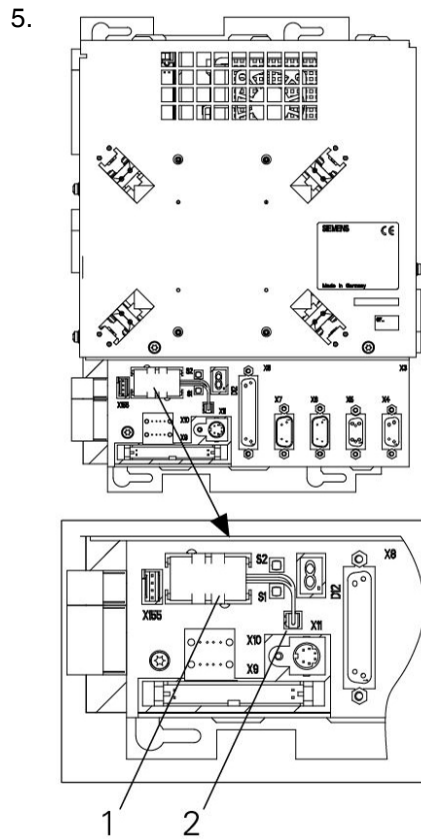

**Example: MMC103 battery replacement**

- 1 Battery compartment
- 2 Connector X11

Replace battery on MMC103. Pull off connector X11, remove and replace battery. Reconnect connector X11. **Make sure of the correct polarity (red = +) when installing.** Indicate the date of the next interval with the appropriate inspection sticker on the battery interval label.

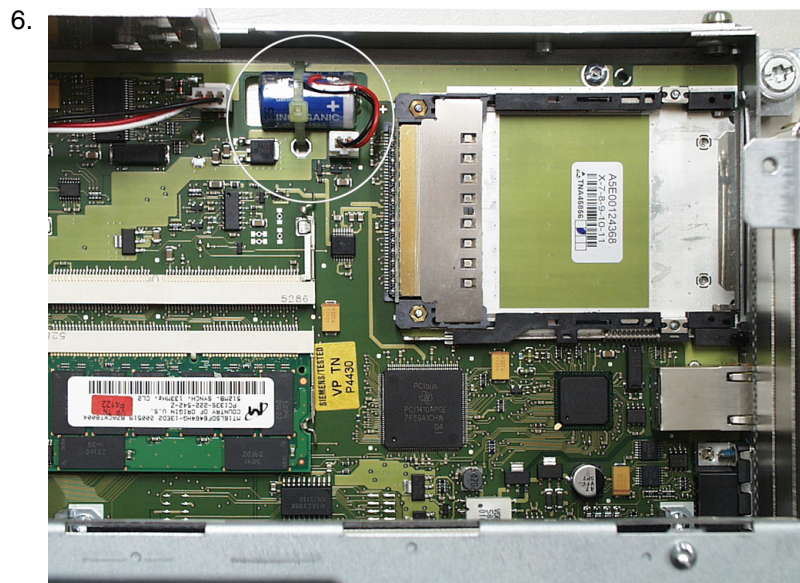

**Example: PCU50.1 and PCU50.2 battery replacement**

Replace battery on PCU50.1 and PCU50.2. Pull off battery connector, remove battery and replace it with a new one. Reconnect connector. **Make sure of the correct polarity (red = +) when installing.** Indicate the date of the next interval with the appropriate inspection sticker on the battery interval label.

7.

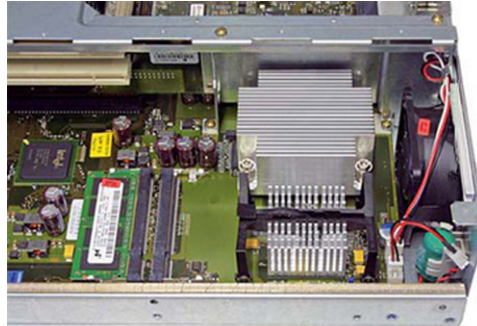

Example: PCU 50.3 battery replacement

Replace battery on PCU 50.3. Pull off battery connector, remove battery and replace it with a new one. Reconnect connector. **Make sure of the correct polarity (red = +) when installing.** Indicate the date of the next interval with the appropriate inspection sticker on the battery interval label.

8.

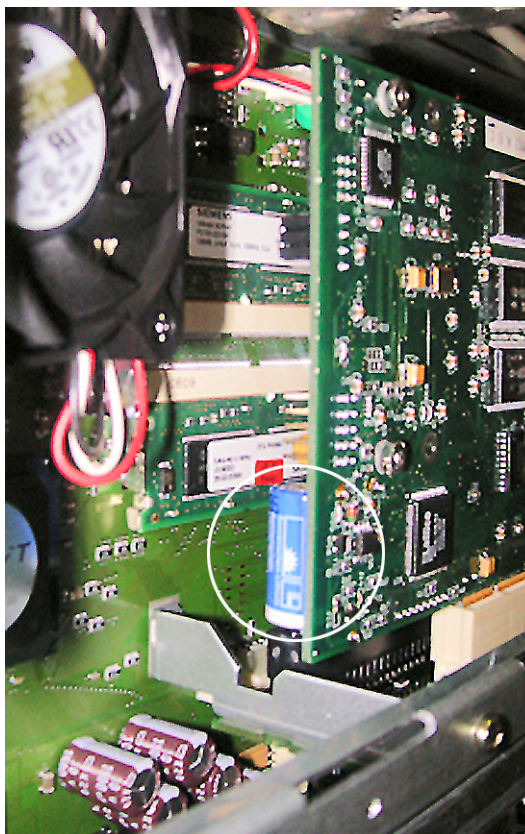

Example: ARTIS battery replacement

Replace battery for ARTIS machine and tool monitoring (option). Pull off battery connector, remove battery and replace it with a new one. Reconnect connector. **Make sure of the correct polarity (red = +) when installing.** Indicate the date of the next interval with the appropriate inspection sticker on the battery interval label.

9. Switch on the machine. After replacing the batteries, the machine can be turned on again. Any error messages such as battery alarms should no longer be displayed. Check date and time and adjust if necessary.

## D640 - Check setting of electrical fuses



Carrying out the maintenance activities described below requires special knowledge. For this reason, these maintenance activities must only be carried out by staff that has received adequate training by the machine manufacturer!

### Procedure

1.



#### **Electric shock**

Power off the machine and wait approx. 30 minutes. Check with a meter if there is still voltage applied to the intermediate circuit.

Check setting of electrical fuses – note this information in the electrical diagrams.



**Service Interval - 8.000 Operating hours**

## Maintenance Summary - 8.000 Operating hours



It is recommended to document the maintenance activities carried out by using the appropriate maintenance log. The maintenance log has the document number LP1602.10101 - 15.08.2022.

**E020** - Replace end position dampers

**E020** - Replace end position dampers

## Orientation

Besides the software end positions and the emergency stop switches, the end position dampers are another safety device to protect the machine from damage. Their job is to absorb the impact force to the spindle bearings.

Therefore, regular inspection of the end position dampers for damage is necessary to prevent damage to the spindle and its bearings.

Position tool carrier such as to allow easy access to the specific end position damper.

## Procedure

1.  Power off the machine and secure it against power on.

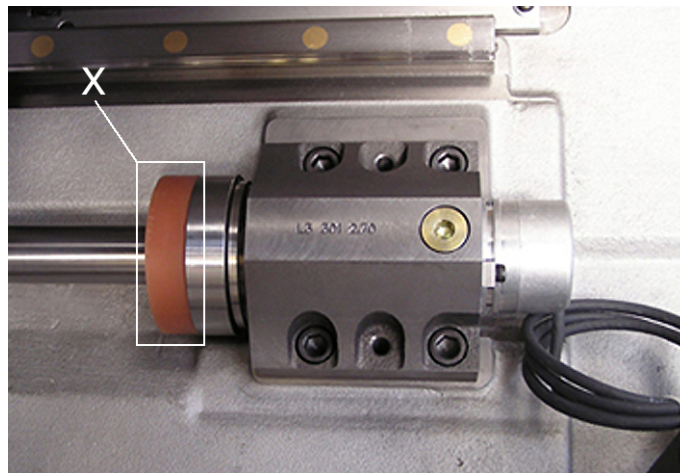

Example: End position damper (X), G200

Remove screws on the end position damper (red/orange).

2. Replace damper. The damper has a slit on one side and can be pushed over the ballscrew by rotating it.
3. Insert new dampers and secure with the screws. Do not tighten the screws with the rated torque. It is sufficient to tighten the screws by hand.



**Service Interval - 5 Years**

## Maintenance Summary - 5 Years



It is recommended to document the maintenance activities carried out by using the appropriate maintenance log. The maintenance log has the document number LP1602.10101 - 15.08.2022.

- I010** - Renewing the pneumatically pilot-controlled cooling lubricant valves
- I020** - Replace the pressure accumulator

**I010** - Renewing the pneumatically pilot-controlled cooling lubricant valves

## Orientation

In the course of the machine's operating time, internal wear of the pneumatically pilot-controlled cooling lubricant valves may occur, with the result that cooling lubricant may penetrate the pneumatic control lines. To avoid consequential damage, **INDEX** recommends replacing these valves after 5 years.

## Requirement



Due to different requirements and/or specifications of the respective manufacturers, be sure to review the respective manufacturer's documentation!



Power off the machine to depressurize the pneumatic system and secure against accidental switching on.

## Procedure

1. Renew valves.

## I020 - Replace the pressure accumulator

### Orientation



According to the pressure equipment directive 97/23/EC, the pressure accumulators built into the machine are of category I/ module A. They are provided with a CE mark by the manufacturer, and a declaration of conformity has been issued. Due to this categorization, the pressure accumulators must be subjected to an external and internal inspection and a strength test by a qualified person after a period of time recommended by the pressure accumulator's manufacturer. For pressure units with gas cushions, an internal inspection is recommended after 10 years at the latest. We recommend to replace the pressure accumulator after 5 years to avoid an internal inspection that is laborious and expensive for this size of pressure accumulator.



Due to different requirements and/or specifications of the respective manufacturers, be sure to review the respective manufacturer's documentation!



The machine operator is obliged to check the pressure accumulator according to applicable rules and directives. Defective pressure accumulators must be disposed of according to applicable rules after they have been depressurized by a qualified technician. The guidelines and regulations applicable in the country of use must be followed.



Screws on the hydraulic system, the connected components, and the supply lines must be tightened to the manufacturer's specified torques.

### Procedure

1. Replace the pressure accumulator.



2.



**Example: Pressure accumulator**

Connect and secure the pressure accumulator. Observe the tightening torque.



**Service Interval - 8 Years**

## Maintenance Summary - 8 Years



It is recommended to document the maintenance activities carried out by using the appropriate maintenance log. The maintenance log has the document number LP1602.10101 - 15.08.2022.

**J005** - Note on replacing the window pane or removing the design pane

**J150** - Replace the window pane

## J005 - Note on replacing the window pane or removing the design pane

### Orientation



The instructions described in this point only serve as information for the subsequent maintenance activity “**replace window pane**” of the respective machines.



If the window pane is damaged, it must be replaced. This is necessary regardless of the extent of damage. Even with minimal damage, the impact resistance of the pane can no longer be guaranteed.



For safety reasons, it is recommended to obtain the window pane directly from the machine manufacturer or its country representative.

The window pane consists of three panes. the inner pane of tempered glass, the central pane of polycarbonate, and the outer pane also made of polycarbonate. The inner pane is relatively resistant. It can be cleaned with any commercially available cleaning agents. Only the center pane is essential for the impact resistance of the window pane. The polycarbonate panes are subject to natural aging and must be replaced at regular intervals.

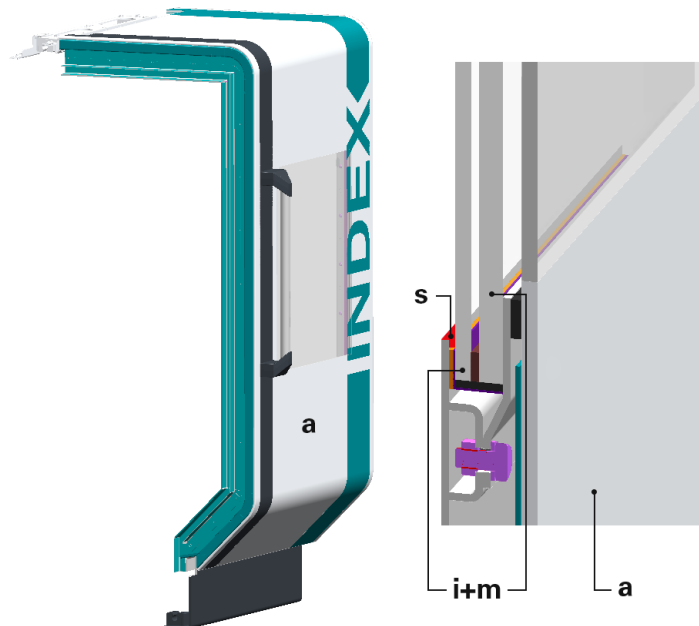

Example: G200.2 Work area door 01 1

- a** Outer pane (design pane made of PMMA – polymethyl methacrylate)
- m** Center pane (polycarbonate)
- i** Inner pane (glass)
- s** Silicone gasket

Depending on the machine type, it may be necessary to remove a handle attached here before dismantling the design disks.

## Requirement



General information. **The values indicated in the table must be strictly observed.**

A		B	C	
			X	Y
ABC	-	33	444	193
C100	-/+	42	581	68
C200	+	58	663	90
G200.2/3	+	56	668	118
B400/B500	+	67	603	48
G220/2	+	84	728	171
G220.3	+	92	707	166
G320.2* <sup>2)</sup>	+	122	693	210
G400.2/G420* <sup>1)</sup> G500.2/G520* <sup>1)</sup>	+	134	776	206
G400.2/G420* <sup>3)</sup> G500.2/G520* <sup>3)</sup>	+	164	739	206

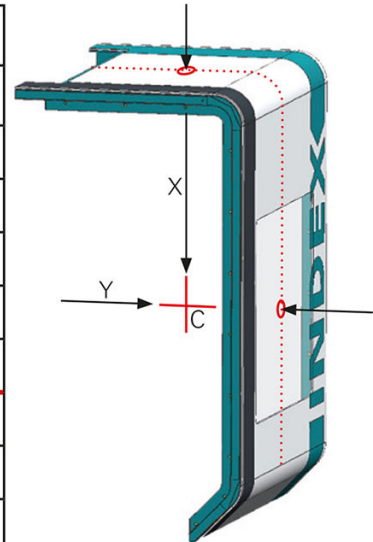

**Example: Design pane specifications for the respective machines**

- A** Machine designation
- B** Weight (kg)
- C** Values for centers of gravity
- Y** Y-value (mm)
- X** X-value (mm)
- \*<sup>1)</sup> Turning length 1600 mm
- \*<sup>2)</sup> Turning length 1400 mm
- \*<sup>3)</sup> Turning length 2300 mm



From a weight of approx. 80kg, the use of lifting equipment (cranes, forklifts or similar) is recommended. The machines marked with + in the table ( **example: design pane specifications ...** ) have threaded bushings at the top of the design pane and are therefore crane-compatible.

If the design pane is not removed using a crane or other lifting equipment but by hand using suction lifters, it is imperative that the current **Load Handling Ordinance (LasthandhabV)** be taken into account. When using suction lifters (see example), be sure to select the appropriate size or type according to the table ( **example: design pane specifications...** ).



The locally valid guide lines and regulations must be taken into consideration.



60kg



100kg

Example: Bohle suction lifter 60 kg-100 kg

## Procedure

1. If you have questions, be sure to contact the **INDEX** service department or an **INDEX** representative.

## J150 - Replace the window pane



Carrying out the maintenance activities described below requires special knowledge. For this reason, these maintenance activities must only be carried out by staff that has received adequate training by the machine manufacturer!

### Orientation



If the window pane is damaged, it must be replaced. This is necessary regardless of the extent of damage. Even with minimal damage, the impact resistance of the glass can no longer be guaranteed.



For safety reasons, it is recommended to obtain the window pane directly from the machine manufacturer.

The window pane consists of three panes. the inner pane (**i**) made of tempered glass, the central pane (**m**) made of polycarbonate, and an outer pane (**a**) made of PMMA (polymethyl methacrylate). The inner pane (**i**) is relatively resistant. It can be cleaned with any commercially available cleaning agents. Only the center pane (**m**) is essential for the impact resistance of the window pane. The polycarbonate pane is subject to natural aging and must therefore be replaced at regular intervals.

After replacing the inner window pane and after the installation work is complete, it must be sealed on the inside of the work area door (**s**). It is necessary to provide a suitable sealant. **The sealant Terostat 930 is used at the factory for this purpose.**

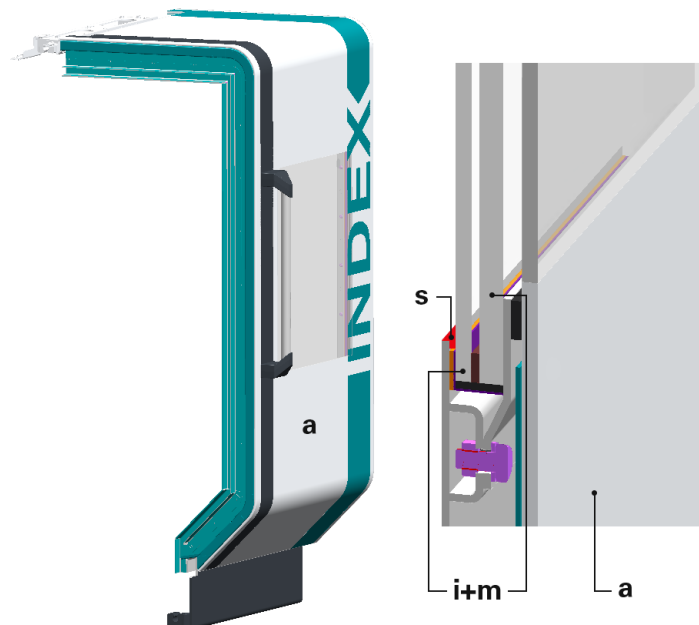

Example: G200.2 Work area door 01 1

- a** Outer pane (design pane made of PMMA – polymethyl methacrylate)
- m** Center pane (polycarbonate)
- i** Inner pane (glass)
- s** Silicone gasket





If sealing compounds from other manufacturers are used, their equivalence must be guaranteed by the supplier or manufacturer in writing.



When mounting and dismounting the front cover/design pane using a crane, **INDEX** recommends using suitable suction lifters to secure it. To ensure safe handling, both the suction surfaces of the suction lifters used and the corresponding areas of the design pane must be carefully cleaned beforehand.

Personal protective equipment -> Use gloves with rubberized palm/inside.

Determine and prepare the storage location for the design pane. To prevent scratching of the design pane, cover the surface at the storage location with suitable tarpaulins, foils, felt mats or similar. Under certain circumstances, the design pane can also remain on the crane near the ground. Shut down and secure the crane and seal off or secure the surrounding area.



Example: Bohle suction lifter (max. 60 kg and max.100 kg)

## Requirement



Before disassembling the design pane, observe the following:

1. It may be necessary to remove a door handle (depending on the machine type).
2. Install the eyebolts (**X**). (included with the delivery)
3. Design pane using round slings (as in 1 and 2 in the **example: Transport design element G420** as described) and lift slightly with a crane. In the case of the variant shown in example 2, it is **essential** to secure the round slings in such a way that they cannot slip.
4. It is essential to ensure that the slinging angle of the slinging ropes/round slings does **not** fall below an angle of 60° in order to prevent diagonal pull and the associated damage to the design pane.

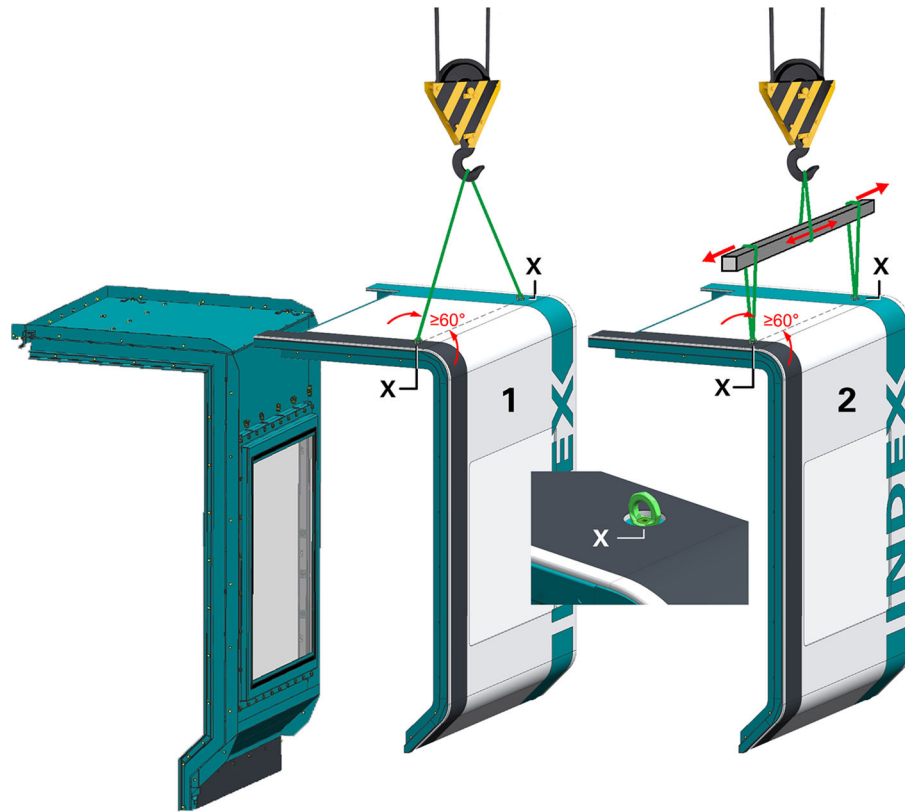

Example: Transport of design element G420

- X Install eyebolts
- 1 Lifting with round slings
- 2 Lifting with short round slings and small crossbeam

## Procedure

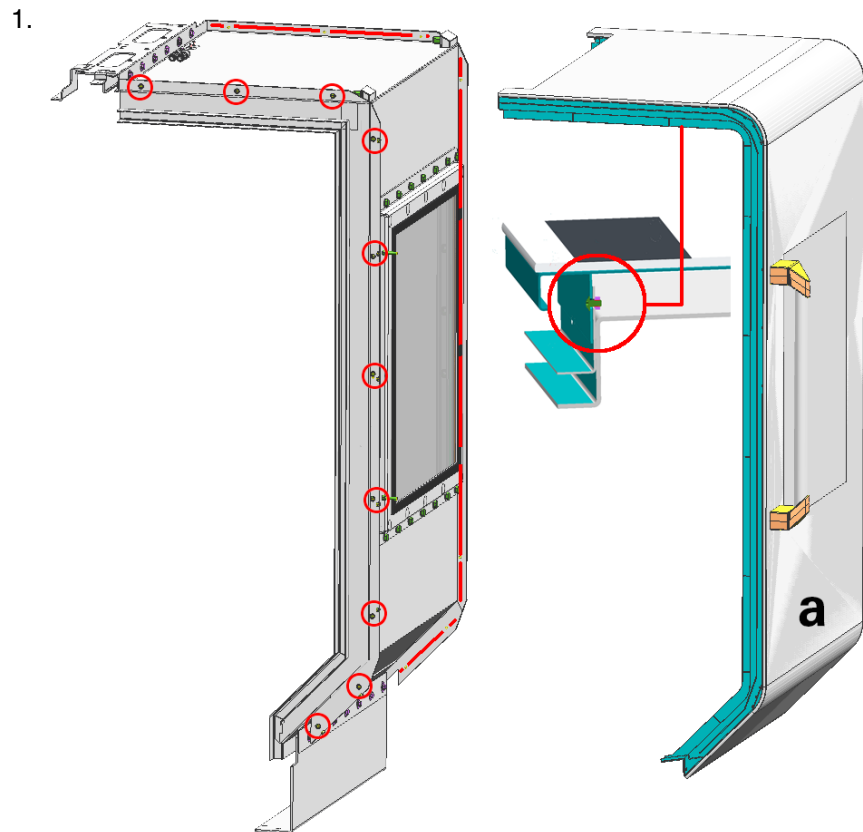

Example: G200.2 Work area door 03 1

The front cover is also the front pane/design pane (**a**). It is screwed to the work area door. Loosen the screws (M6) along the contour on both sides and remove (Fig. 03 1). Remove front cover/pane, carefully place aside and secure against tipping over.

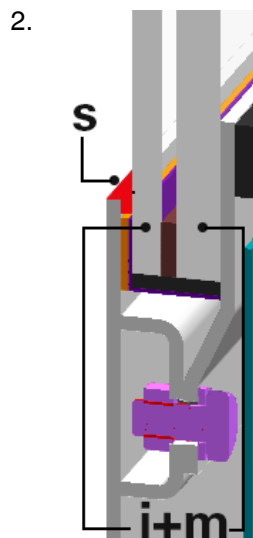

Example: G200.2 Work area door 06

Cut the silicone sealing (**s**) on the inside of the window pane (see Fig.\_06) with a suitable knife.

3.



Assistance of a second person to hold the glass is recommended for the activity below. This generally also applies to the installation of the new pane, in particular when sealing and fastening the clamping frame with screws.

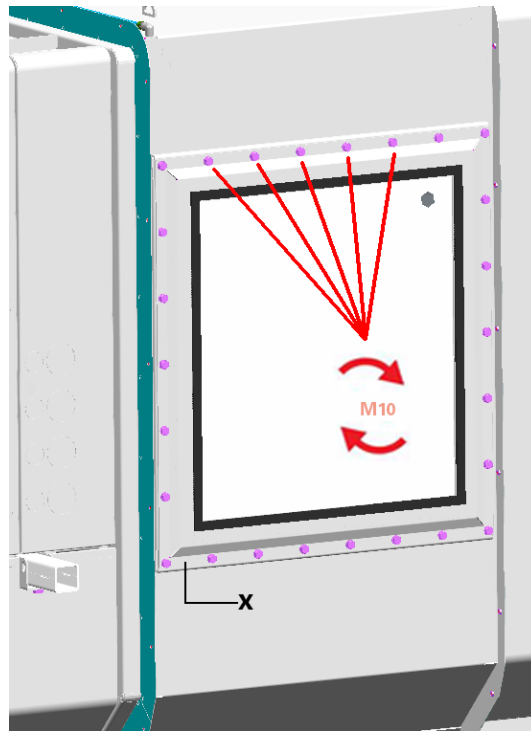

Example: G200.2 Work area door 07

Remove the clamping frame (**x**) of the glass package. Loosen and remove all screws from the clamping frame (see Fig\_07).

4.

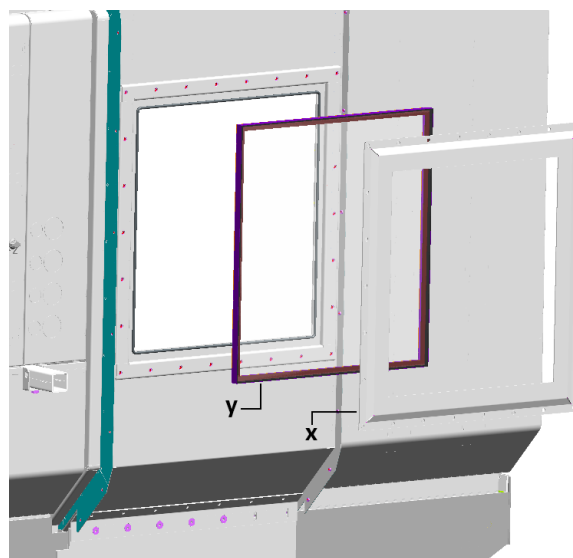

Example: G200.2 Work area door 04

Remove the clamping frame (**x**) and glass package (**y**). (See Fig.\_04)

5. For assembly, follow the steps in reverse order. Ensure proper cleanliness during the installation.

6.  Make sure of cleanliness and stress-free installation when mounting the clamping frame into the work area door.

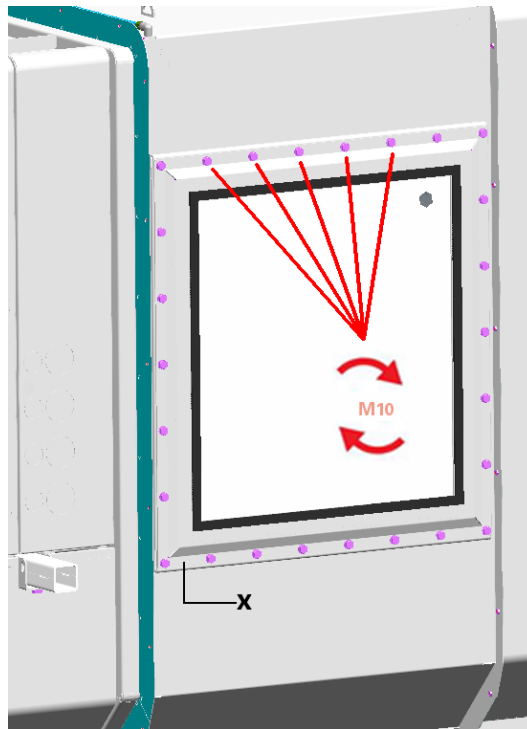

Example: G200.2 Work area door 07

Reinstall the glass package and clamping frame. After installation, tighten all screws (Fig.:\_07) to the prescribed torque.

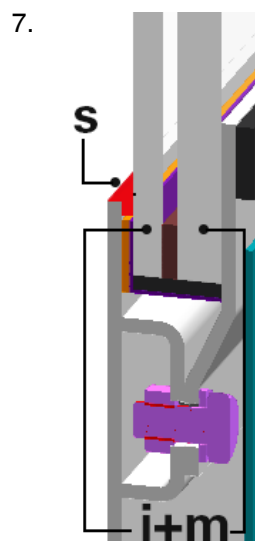

Example: G200.2 Work area door 06

Seal the inner pane in the work area with sealant (**s**) again. After the assembly of the panes and frame parts, the inner pane must be sealed using a sealant (Terostat 930 gray is used at the factory). See Fig.:\_06

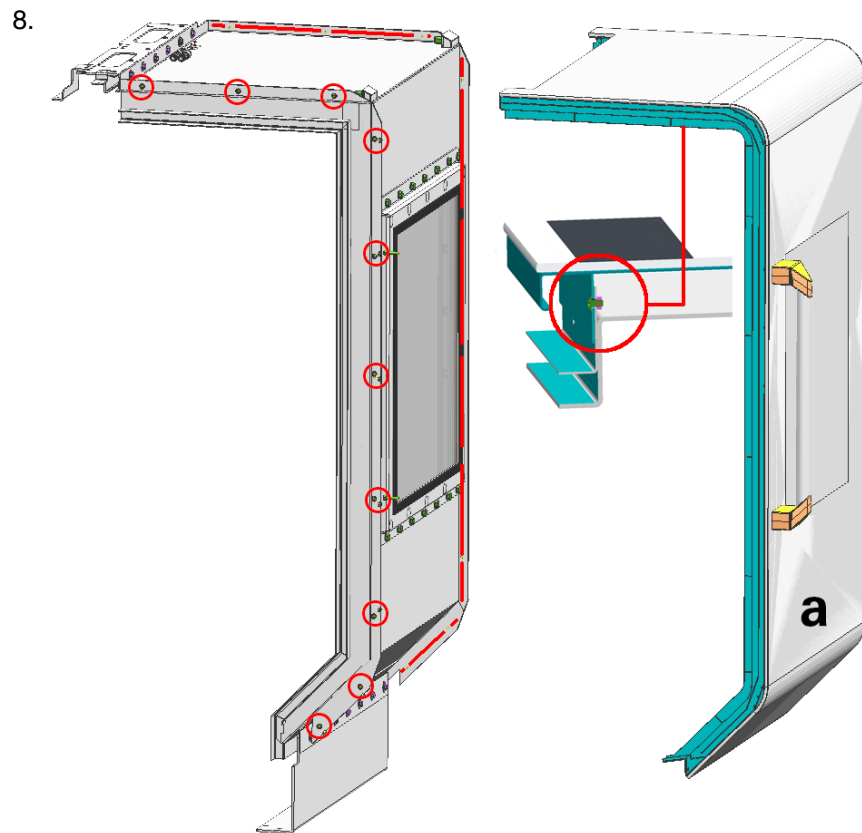

Example: G200.2 Work area door 03 1

Refit the front cover or front pane/design pane (**a**) and screw it on again on both sides along the contour using the screws (M6 – 11 each).



# INDEX

**INDEX-Werke GmbH & Co. KG  
Hahn & Tessky**

Plochinger Str. 92  
D-73730 Esslingen, Germany

Fon +49 711 3191-0  
Fax +49 711 3191-587

[info@index-werke.de](mailto:info@index-werke.de)  
[www.index-werke.de](http://www.index-werke.de)